

plug+play

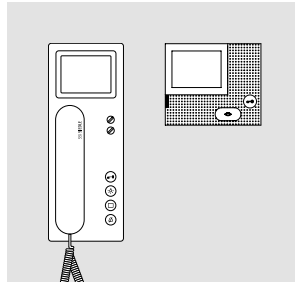

**System Manual**  
**In-Home bus: Video**  
Issue 2021

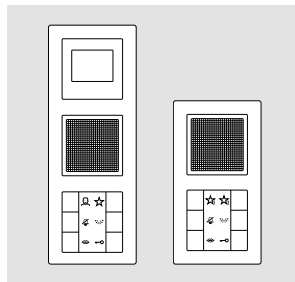
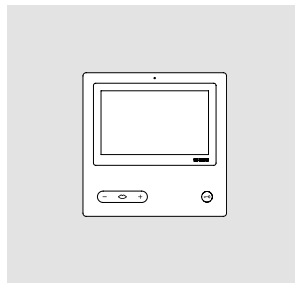

**SIEDLE** Systemtechnik  
In-Home

# Contents

<b>1 In-Home bus: Video</b>			
System description	3		
<b>2 Siedle Systemtechnik</b>			
Jung indoor stations	3		
<b>3 Safety remarks</b>			
Danger	3		
<b>4 Configuration, conductor lengths</b>			
User assignment	4		
Single line system	6		
Single line system with bus distributor	8		
Single line system with bus distributor and ZBVNG 650-...	9		
Multiple line system	10		
Example to determine the attenuation	12		
Installation with YR	13		
Installation with J-Y(St)Y, increased range	13		
Bus distributor for flush mounted junction boxes	14		
Attenuation values	15		
Bus distributor for top hat rail mounting	16		
Attenuation values	17		
<b>5 In-Home: Video users</b>			
Door loudspeakers, call buttons	18		
Door stations	19		
Bus and external cameras	20		
Bus distributor, Bus video modulator	22		
Power supply, line rectifiers	24		
Switching, controlling, converting	25		
Gateway, Software, License, PC interface, DoorCom	27		
Bus indoor devices	29		
Jung indoor stations	32		
Table-top accessory	33		
Accessory	34		
<b>6 Installation</b>			
General information	36		
Bus call button module, bus video line rectifier	37		
Modular Jung indoor station	38		
<b>6.1 Installation video</b>			
Siedle Vario with BVPC 850-0	40		
Siedle Vario with SG 150/650-0	42		
Siedle Vario	44		
Side circuit	46		
Star-shaped installation	47		
Siedle Compact	48		
Siedle custom-fit door loudspeaker	50		
Siedle Classic	52		
Siedle Steel	54		
Siedle Vario 2 door stations	56		
Multiple line system	58		
Call via display call module	60		
Additional external camera	62		
<b>6.2 Installation audio &amp; video</b>			
Siedle Vario	64		
DoorCom Analog DCA 650-...	66		
Siedle Vario 3 door stations	68		
Multiple line system	70		
<b>6.3 Siedle Systemtechnik installation</b>			
Jung video indoor station	72		
Jung audio & video indoor station	74		
Jung standard audio indoor station & video indoor station	76		
Siedle and Jung indoor stations combined	78		
<b>7 Programming</b>			
Overview of functions	80		
Remarks	86		
<b>7.1 Programming – manual</b>			
Activating the bus line rectifier	87		
Activating the bus door loudspeaker	88		
Activating the indoor devices	89		
Activating Jung indoor devices	90		
Door call to Siedle Basic	91		
Door call to bus telephone	92		
Door call to Smart Gateway/ Smart Gateway Professional	93		
Door call Compact to Siedle Basic	94		
Door call Compact flush mounting to Siedle Basic	95		
Door call to bus video panel	96		
Door call via the storey call button	97		
Parallel door call	98		
Internal call	99		
Dialling the door station	101		
Selection external camera	102		
Call differentiation of 2 door stations	103		
Additional contact on the BSM 650-...	104		
Button of a bus telephone on the BSM 650-...	105		
Deleting the assignment on the BSM 650-...	106		
Parallel door call to BSE 650-...	108		
Door call to BSE 650-...	109		
Button of a bus telephone on the BSE 650-...	110		
Bus secondary signal unit BNS 750-...	111		
Call via DRM 612-...	112		
Call via COM 611-...	113		
Door call to Jung indoor station	114		
Parallel door call to Jung indoor station	115		
Internal call between Jung indoor stations	116		
<b>7.2 Programming – Plug+Play</b>			
Basics	118		
Example of a 4-family home	120		
Procedure – Example	121		
<b>7.3 Programming – with PC</b>			
BPS 650-... and PRI 602-... USB	122		
<b>8 Supplementary functions</b>			
Switching and control functions	123		
Switching and control functions	124		
Door release actuation	126		
Parallel door call, supplementary power supply, video memory	128		
Storey call parallel switching	132		
Supplementary contact, radio chime, pilfer safeguard	133		
Staircase light/Outside light	134		
<b>9 Servicing</b>			
Restart, exchange, operating mode	135		
Operating mode switch BVNG 650-...	136		
LED displays BVNG 650-...	137		
Measured values	138		
<b>10 Glossary, Index</b>			
	139		

## 1 In-Home bus: Video

### System description

#### Configuration "Single line"

The In-Home bus: Video features the same basic structure as a Siedle In-Home bus: Audio installation. Here too, the installation comprises a two-core line. The essential difference to the In-Home bus: Audio is supplementary transmission of the video signal to the cores.

Up to 31 different users can be connected, e.g. bus telephones with video, handsfree bus telephones with video, door stations or devices for switching and control functions. Technically speaking, one device can encompass several users.

If the building installation permits, installation can be performed between one bus telephone with video and the next bus telephone with video. If the building installation does not permit looping through between bus telephones, additional bus video distributors must be used. Without a bus video distributor, no nodes or branches are permissible in the line.

#### Configuration "Multiple line"

In-Home bus: Video "single line" system is restricted to 31 users; In order to connect more than 31 users, up to 15 lines can be coupled together. Each line requires its own bus video line rectifier BVNG 650-...

## 2 Siedle Systemtechnik

### Jung indoor stations

"Siedle Systemtechnik" and the relevant logo are used to describe devices, components or systems which are not manufactured and designed by Siedle but are fitted with Siedle technology. The Systemtechnik logo guarantees technical compatibility with the Siedle system world. Products identified with "Siedle Systemtechnik" may therefore be used without restrictions as components of a Siedle communication system.

#### Jung indoor stations in switch design

Within the framework of a cooperation agreement with the company Jung, Siedle equips Jung indoor stations with "Siedle Systemtechnik". Indoor stations from Jung which bear the Systemtechnik logo on their components, their packaging or the product information, are fully compatible with Siedle technology. They are integrated in this manual as Siedle system components.

**SIEDLE** Systemtechnik  
In-Home

## 3 Safety remarks

### Danger



Mounting, installation and servicing work on electrical devices may only be performed by a suitably qualified electrician. Failure to observe this regulation could result in the risk of serious damage to health or fatal injury due to electric shocks.

- When working at the device, observe the remarks relating to mains cut-off.
  - Operation at an altitude of up to 2000 m above sea level.
  - Observe EN 62368-1!
- In a building installation, an all-pole mains switch with a contact opening of at least 3 mm must be provided. The device must not be exposed to water drops or sprayed water! Sufficient ventilation must be ensured. Pay particular attention to ensure that ventilation slots are not covered.
- Ensure maximum fusing of 16 A for the mains connection in the building installation.
  - When planning large-scale (complex) systems, the distributor space required for the switch panel mounting devices must be taken into consideration in the distributor planning process.
  - No external voltages >30 V AC/DC may be applied to bus users.

#### Devices with 230 V connection

In accordance with DIN VDE 0100 part 410, section 411.1.3 attention must be paid to ensuring a safe separation between system lines and the mains voltage; i.e. system and mains cores must not be permitted to touch! The system line cable (extra-low safety voltage) must be stripped back by the minimum possible.

## 4 Configuration, conductor lengths

### User assignment

#### Devices occupying 1 user

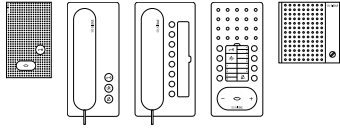

AIB 150-...  
BTS 850-...  
BTC 850-...  
BFC 850-...  
BNS 750-...

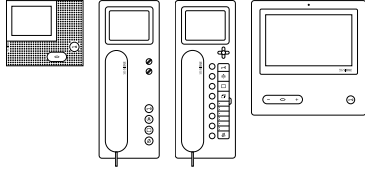

VIB 150-...  
BTSV 850-...  
BTCV 850-...  
BVPC 850-...

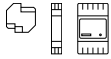

BSE/BEM 650-...  
BSE/BEM 651-...  
BSM 650-...

#### Devices occupying 2 users

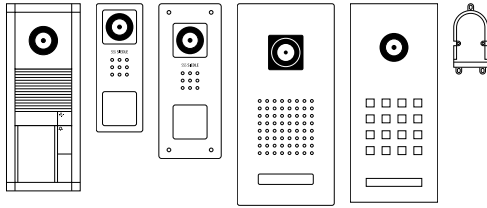

BTLM 650-...  
CV 850-x-...  
CVU 850-x-...  
CL V130 0x B-02  
STL ...  
BTLE 050-...

#### Devices with variable user assignment (depending on programming)

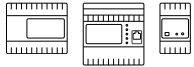

DCA 650-...  
SG 150/650-...  
BVM 650-...

#### Devices occupying no users

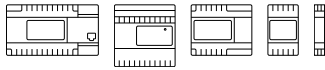

BNG/BVNG 650-...  
NG 706-30/33-...  
NG 602-...  
TR 603-...  
PSM 1 12 24



BCMC 650-...  
BCM 653/658-...  
BTM 650-...

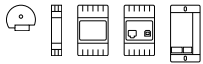

BAA/BVU/BVVS 650-...  
BAVU/BVU/BVVS 652-...  
BIM 650-...  
PRI 602-... USB  
BRMA 050-...

---

**Devices occupying 1 user**

---

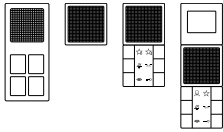

SI 4 A ..  
 SI AM ...  
 SI AI ...  
 SI VI ...

---

**Devices occupying no users**

---



SI VM ...  
 SI TM .. 5073  
 SI TM .. 5093

---

## 4 Configuration, conductor lengths

### Single line system

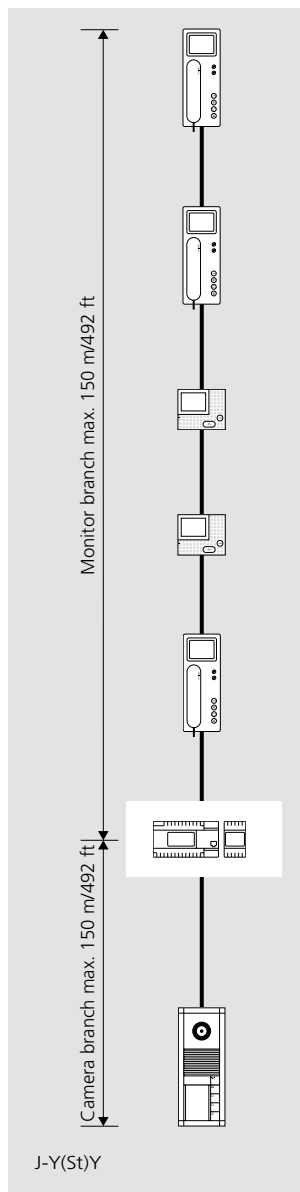

#### Configuration of In-Home: Video

The basic Siedle In-Home bus installation type is the single line system.

Within this one line, installation takes place from one device to the next, provided this is allowed by the building installation.

In buildings with a side circuit and individual branches into the apartments, the bus video distributor must be used. A maximum of 31 users are admissible within any one line. Users are defined as devices which occupy their own address within the bus. If more than 31 users are required, additional lines must be configured. With only a few exceptions, all devices are assigned an address. Up to 15 lines with 31 users each can be configured.

#### Camera branch and monitor branch

Within a line, a distinction is made between the camera branch and the monitor branch. Video door stations are connected to the camera branch, while bus telephones with video are connected to the monitor branch. If the installation requires an additional monitor branch, so-called bus distributors must be used.

#### Users without video

In the case of In-Home: Video, audio users can only be connected via a bus audio decoupler BAA 650-... Switching and control devices are also connected to the BAA 650-...

#### Power supply

The nerve centre of every line is the bus video line rectifier, which controls all the system functions. The camera branch and monitor branch are connected to it via separate terminals.

#### Conductor material

Telecommunication or light current conductors can be used for installation:

J-Y(St)Y	Twisted pair conductors, shielded
CAT	Network cable
A-2Y(St)2Y	Buried telecommunication cable
YR	Light current conductor 0.8 mm core diameter

The In-Home bus must be installed on one pair of cores when using J-Y(St)Y, and when using a YR conductor, on two YR cores positioned side by side. Using J-Y(St)Y conductors reduces the likelihood of interference.

#### Conductor length

Conductor material J-Y(St)Y cable with 0.8 mm diameter:

- max. 150 m from the bus video line rectifier to the most distant user in the monitor branch
- max. 150 m from the bus video line rectifier to the most distant user in the camera branch

**With a core diameter of 0.6 mm, the range is halved.**

#### Network cable

Diameter	Conductor length
0,405 mm AWG 26	40 m
0,511 mm AWG 24	60 m
0,644 mm AWG 22	100 m

Within the line, the maximum length of the conductor material must not exceed 1,500 m.

Systems can also be configured with using conductor material YR with a core diameter of 0.8 mm. This will significantly reduce operating ranges.

For more information, see page 13

When installing, ensure without fail that the camera branch and monitor

branch are not laid in the same cable. Forward and return lines to a bus telephone with video must not be laid in the same cable.

Otherwise, picture disturbance may result.

If installation from one bus telephone to the next bus telephone is not possible, bus distributors must be used. In this case, attenuation of the conductor material and bus distributors must be additionally taken into consideration.

### **Terminating resistor**

Transmission of signals within Siedle In-Home: Video takes place using high-frequency technology.

In order to avoid disturbance on the bus cores, the end of each monitor branch must be terminated with an RC element. The RC element comprises a resistor with 100 Ohm and a capacitor with 1 nF. In its as-delivered status, each bus telephone with colour monitor has a small fitted circuit board with this terminating resistor at output terminals TaM/TbM.

## 4 Configuration, conductor lengths

### Single line system with bus distributor

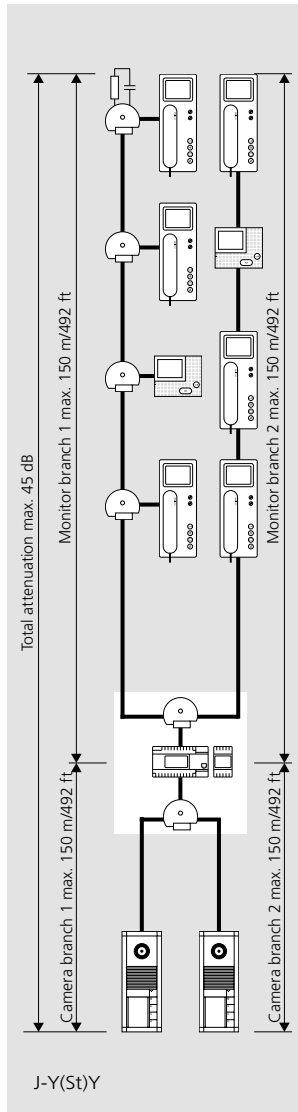

#### Conductor length with bus distributor

If the use of bus distributors is necessary for installation, in addition to the maximum range, attenuation of the bus distributors and conductor material must be additionally taken into account.

The following information relating to conductor lengths refers to one camera branch and one monitor branch. If several branches are installed within a line, the information is applicable to each branch. Whichever value (attenuation or conductor length) is reached first is applicable as a specification of the admissible value.

#### Conductor length

Conductor material J-Y(St)Y cable with 0.8 mm diameter:

- max. 150 m from the bus video line rectifier to the most distant user in the monitor branch
- max. 150 m from the bus video line rectifier to the most distant user in the camera branch
- max. 45 dB attenuation from the most distant user in the camera branch to the most distant user in the monitor branch

**With a core diameter of 0.6 mm, the range is halved.**

#### Network cable

Diameter	Conductor length
0,405 mm AWG 26	40 m
0,511 mm AWG 24	60 m
0,644 mm AWG 22	100 m

The maximum admissible attenuation is 45 dB within a line. General rule for J-Y(St)Y cable material:

- 10 m conductor length corresponds to 2 dB attenuation!

Within the line, the maximum length of the conductor material must not exceed 1,500 m.

If the maximum admissible attenuation of 45 dB is exceeded, the bus video line rectifier accessory ZBVNG 650-... must be used in the BVNG 650-... to compensate for this loss.

#### Signal transmission

Only signals from the In-Home bus may be transmitted over the laid conductor material. No additional transmissions, for example PBX extensions of a telephone system, S0 Bus (ISDN) or data lines of an alarm system in the same cable. The camera branch and monitor branch must be laid separately and must not be located in the same cable. This can result in disturbance to the picture composition.

#### Terminating resistor

Transmission of signals within Siedle In-Home: Video takes place using high-frequency technology. In order to avoid disturbance on the bus cores, the end of each monitor branch must be terminated with an RC element. The RC element comprises a resistor with 100 Ohm and a capacitor with 1 nF. In its as-delivered status, each bus telephone with colour monitor has a small fitted circuit board with this terminating resistor at output terminals TaM/ TbM.



## Single line system with bus distributor and ZBVNG 650-...

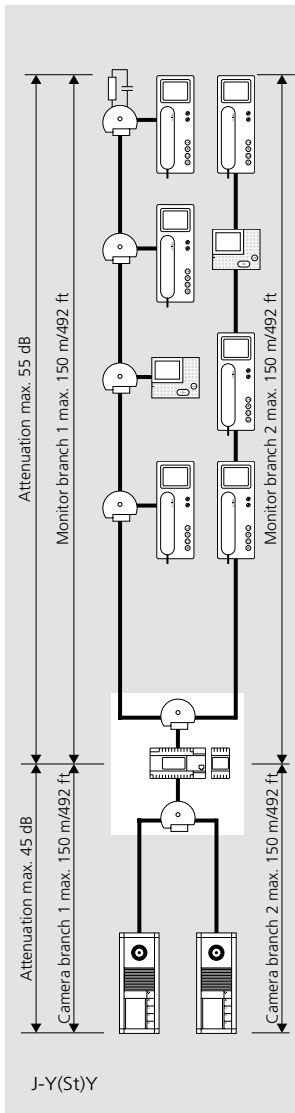

### Conductor length with bus distributor and ZBVNG 650-...

The ZBVNG 650-... accessory amplifies the video signal, so permitting greater attenuation in the camera branch and monitor branch. To do this, the inserted jumper card in the BVNG 650-... is removed and the ZBVNG 650-... inserted in the same slot.

The following information relating to conductor lengths refers to one camera branch and one monitor branch. If several branches are installed within a line, the information is applicable to each branch. Whichever value (attenuation or conductor length) is reached first is applicable as a specification of the admissible value.

The limiting values must be adhered to for each of the branches.

### Conductor length

Conductor material J-Y(St)Y cable with 0.8 mm diameter:

- max. 150 m from the bus video line rectifier to the most distant user in the monitor branch
- max. 150 m from the bus video line rectifier to the most distant user in the camera branch
- max. 45 dB attenuation from the bus video line rectifier to the most distant user in the camera branch
- max. 55 dB attenuation from the bus video line rectifier to the most distant user in the monitor branch

**With a core diameter of 0.6 mm, the range is halved.**

### Network cable

Diameter	Conductor length
0,405 mm AWG 26	40 m
0,511 mm AWG 24	60 m
0,644 mm AWG 22	100 m

Within the line, the maximum length of the conductor material must not exceed 1,500 m.

# 4 Configuration, conductor lengths

## Multiple line system

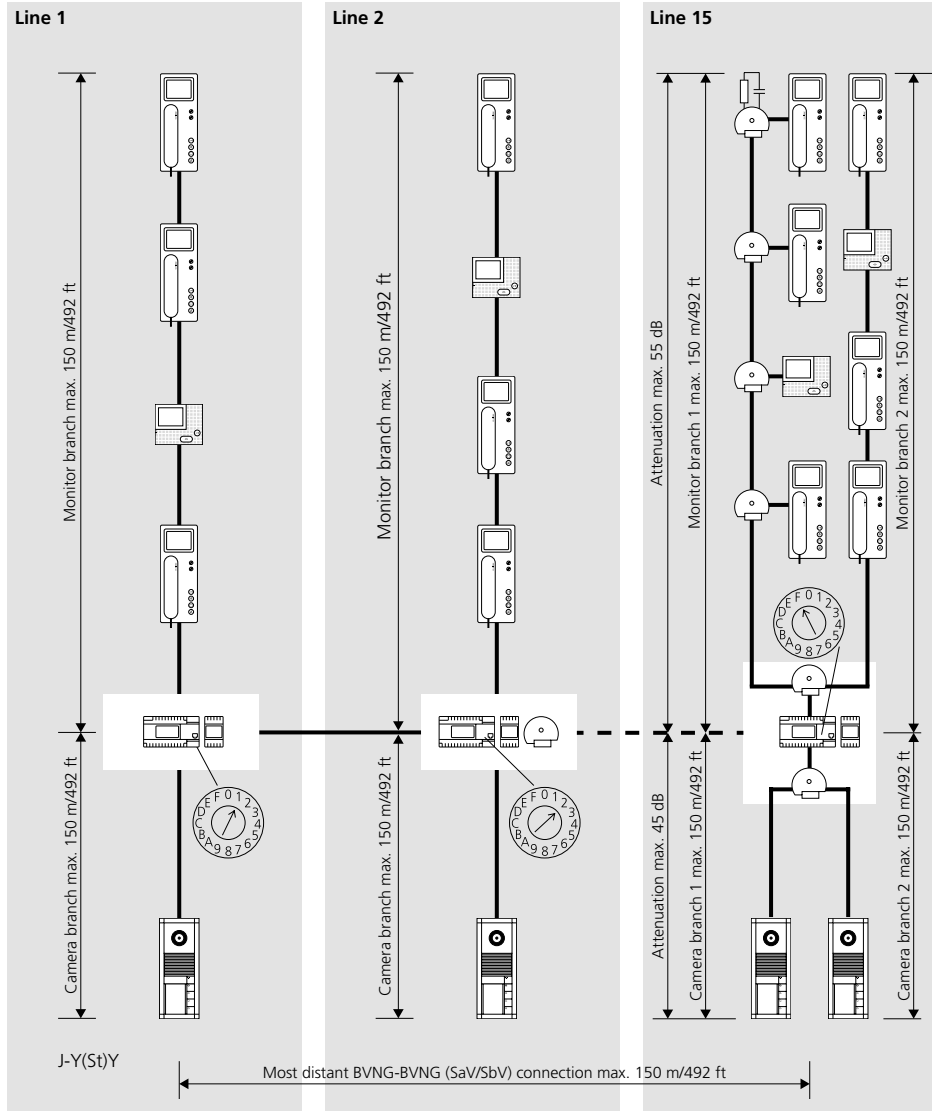

### **Configuration of the multiple line system**

A multiple line system comprises individual lines which are linked together by two cores. The lines are connected at the bus video line rectifier using terminals SaV and SbV. In multiple line systems, speech and video connections are possible from one line to another. To generate a multiple line system, the bus line rectifier accessory ZBVG 650-... is required in one of the bus video line rectifiers.

**In each bus video line rectifier, the bus video line rectifier accessory ZBVG 650-... is required.**

### **Differentiation between line 1 and line 2 ...**

The lines are consecutively numbered using the address switch "Adr." at the bus video line rectifier BVNG 650-... Up to 15 lines can be linked via the SaV and SbV cores. The bus video line rectifier is connected via the bus distributor BVVU 650-...

At the bus video line rectifier, a bus line rectifier can be connected directly via the cores Sa and Sb in order to link a line with In-Home: Audio. During installation, ensure that each line is laid in a separate cable.

### **Functions applicable across individual lines**

Door calls, selective door dialling and switching and control functions can also be used across individual lines. Internal speech communication and call forwarding between users is only possible within a line.

### **Conductor length between the lines**

The admissible conductor lengths within a line are identical to those in a single line system. In addition, the admissible conductor length between the bus video line rectifiers must be taken into account.

This must be no more than 150 m (45 dB) between the most distant bus video line rectifiers (using J-Y(St)Y cable with 0.8 mm diameter).

As only data exchange takes place between the bus video line rectifiers, i.e. no current flows, it is possible to achieve a range of up to 300 m using a CAT installation cable (e.g. CAT5).

In a multiple line system comprising only 2 lines, connection between the two bus video line rectifiers is possible without bus distributor BVVU 650-...

The maximum admissible lengths within a line and the attenuation values continue to be valid.

When installing, ensure without fail that the camera branch and monitor branch are not laid in the same cable. Forward and return lines to a bus telephone with video must not be laid in the same cable. Otherwise, picture disturbance may result.

## 4 Configuration, conductor lengths

Example to determine the attenuation

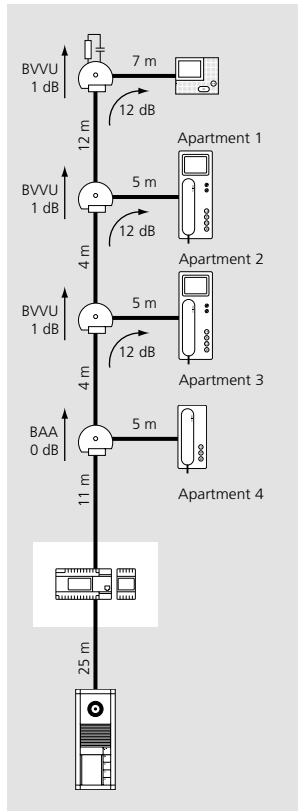

### Example to determine the attenuation with bus distributor

The system is installed using J-Y(St)Y cable 0.8 mm diameter. This means that 10 m of conductor length have an attenuation of 2 dB. Apartment 4 is decoupled using a bus audio decoupler BAA 650-..., apartment 1 - apartment 3 are connected via bus video distributor BVVU 650-...

### Attenuation in the camera branch

Conductor length between the door station and the sub-distributor 25 m.  
25 m = 5 dB

### Attenuation in the monitor branch to apartment 3

Conductor length of the installation cable. All values added, from the bus video line rectifier to the bus telephone:  
 $11\text{ m} + 4\text{ m} + 5\text{ m} = 20\text{ m}$   
20 m conductor length corresponds to 4 dB attenuation  
Attenuation of the bus distributor BVVU 650-... = 12 dB  
Total value:  
12 dB distributor + 4 dB conductor = 16 dB

This means that apartment 3 has a total attenuation from the camera to the bus telephone of  $16\text{ dB} + 5\text{ dB} = 21\text{ dB}$

### Attenuation in the monitor branch to apartment 1

Conductor length of the installation cable. All values added, from the bus video line rectifier to the bus telephone:

$11\text{ m} + 4\text{ m} + 4\text{ m} + 12\text{ m} + 7\text{ m} = 38\text{ m}$   
38 m of conductor material add up to 7.6 dB

Attenuation of all bus distributors:  
1 dB + 1 dB + 12 dB = 14 dB  
Total value:

14 dB distributor + 7.6 dB conductor = 21.6 dB

Apartment 1 has a total attenuation from the camera to the bus telephone of  $21.6\text{ dB} + 5\text{ dB} = 26.6\text{ dB}$

The maximum value with this example would be 26.6 dB from the most distant video door station to the most distant bus telephone, the maximum admissible would be 45 dB.

With greater attenuation over 45 dB, accessory ZBVNG 650-... can be used to increase attenuation in the camera branch to 45 dB and in the monitor branch to 55 dB.

On the following double page, the precise function of the bus distributor is explained in detail.

Installation with YR  
 Installation with J-Y(St)Y, increased range

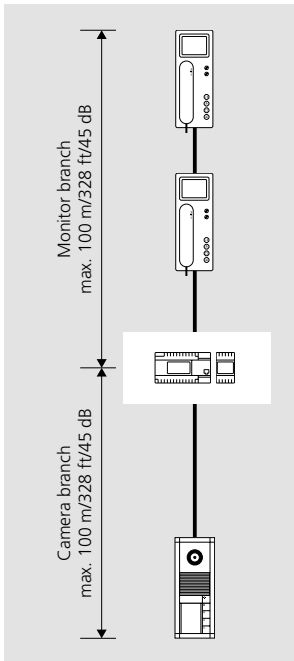

**Installation with YR**

Systems can also be configured with using conductor material YR with a core diameter of 0.8 mm. However, this will significantly reduce operating ranges. Even if parts of the system are configured using YR 0.8 mm core diameter conductors, the reduced range will still come into effect.

Conductor material YR cable with 0.8 mm core diameter:

- max. 100 m from the bus video line rectifier to the most distant user in the monitor branch
- max. 100 m from the bus video line rectifier to the most distant user in the camera branch

If it is necessary to use bus distributors within the installation, the attenuation of the conductor material and the bus distributor must be taken into consideration. With a core diameter of 0.6 mm, the range is halved.

Installation is also possible in a multiple line system with 0.8 mm conductor material.

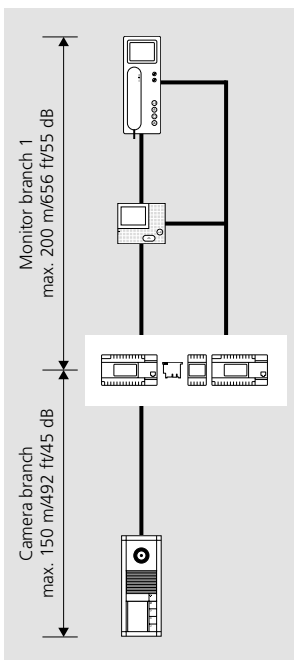

**Installation with J-Y(St)Y, increased range**

The ZBVNG 650-... must be plugged into the BVNG 650-...!

When using cable material J-Y(St)Y with 0.8 mm, it is possible to increase the distance from the bus video line rectifier to the bus telephones with colour monitor. In this case, each bus telephone with colour monitor must be provided with an additional power supply (e.g. line rectifier NG 706-30/33-...). At the bus video line rectifier BVNG 650-... the **operating mode switch must be set to 2**.

Conductor material J-Y(St)Y cable with 0.8 mm diameter:

- max. 200 m from the bus video line rectifier to the most distant user in the monitor branch.

In a **multiple line system** this facility can be used to increase the range in every line.

In the case of a parallel call to several bus telephones with video, the admissible conductor length of the power supply must be noted. For more information, see page 128

Within the line, the maximum length of the conductor material must not exceed 1,500 m.

Installation is also possible in a multiple line system with 0.8 mm conductor material.

## 4 Configuration, conductor lengths

Bus distributor for flush mounted junction boxes

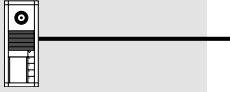
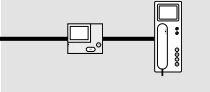
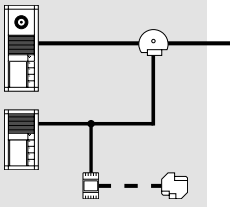
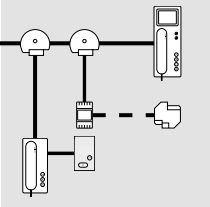
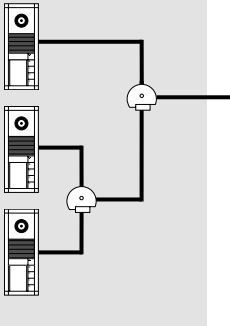
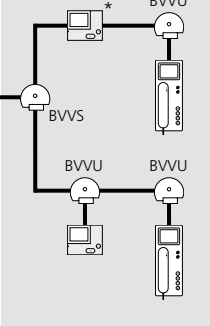
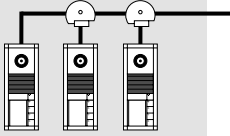
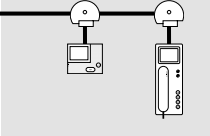
<p><b>Camera branch</b></p> 	<p><b>Monitor branch</b></p> 	<p><b>Camera branch:</b> No bus distributor required with a door station.</p> <p><b>Monitor branch:</b> No bus distributor required when looping through from bus telephone to bus telephone. The integrated bus distributor in the bus telephones is used.</p> <p><b>Attenuation:</b> No attenuation to be considered.</p>
<p>BAA 650-...</p> 	<p>BAA 650-...</p> 	<p><b>BAA 650-... in the camera branch:</b> Connection of audio users (e.g. BTLM 650-... or BTLE 050-...) or users for switching and control functions.</p> <p><b>BAA 650-... in the monitor branch:</b> Connection of audio users (AIB 150-..., BTS/BTC/BFC 850-..., DCA 650-...) or users for switching and control functions.</p> <p><b>Attenuation:</b> No attenuation to be taken into consideration if decoupled.</p>
<p>BVVS 650-...</p> 	<p>BVVS 650-...</p> 	<p><b>BVVS 650-... in the camera branch:</b> More than one video door station in the camera branch with "star shaped" conductor routing.</p> <p><b>BVVS 650-... in the monitor branch:</b> Within the In-Home bus: Video more than one side circuit is required.</p> <p><b>Attenuation:</b> The attenuation from BVVS 650-..., BVVU 650-... and the conductor length must be taken into consideration.</p> <p>* The device must not be a table-top device, as there is an open cable end in the case of a device that is not plugged in.</p>
<p>BVVU 650-...</p> 	<p>BVVU 650-...</p> 	<p><b>BVVU 650-... in the camera branch:</b> More than one video door station in the camera branch with "loop through" conductor routing.</p> <p><b>BVVU 650-... in the monitor branch:</b> Connection of a bus telephone with monitor to a side circuit with "looped through" conductor routing.</p> <p><b>Attenuation:</b> The attenuation from BVVU 650-... and the conductor length must be taken into consideration.</p>

## Attenuation values

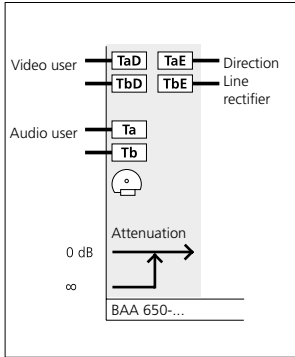

### BAA 650-... in the camera branch

Connection of a door station without video (e.g. BTLM 650-.../ BTLE 050-...) or switching and control devices (BSE/BSM/BEM 650-...) at the Siedle In-Home bus: Video. For more information, see page 68

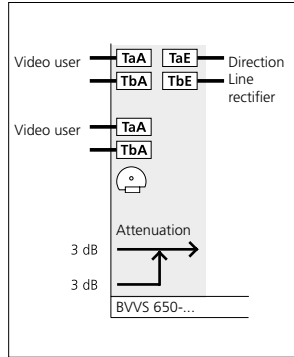

### BVVS 650-... in the camera branch

When more than one video door station is operated within a camera branch. For more information, see page 56

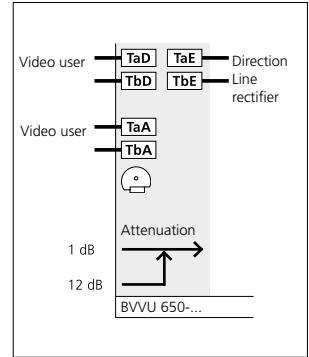

### BVVU 650-... in the camera branch

When more than one video door station is operated within a line.

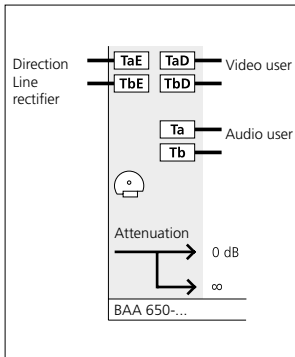

### BAA 650-... in the monitor branch

Connection of pure audio users (AIB 150-..., BTS/BTC/BFC 850-..., DCA 650-...) or users for switching and control functions (BSE/BSM/BEM 650-...) within an Siedle In-Home bus: Video. For more information, see page 64

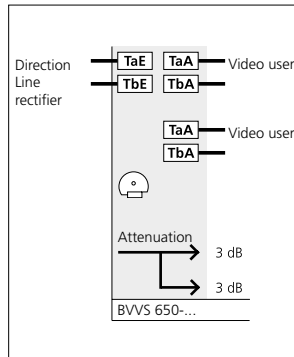

### BVVS 650-... in the monitor branch

If more than one rising main/side circuit is required within In-Home bus: Video. At the outputs, further distribution must take place via BVVU 650-... or BAA 650-... Direct connection of devices is only permitted for permanent installations.

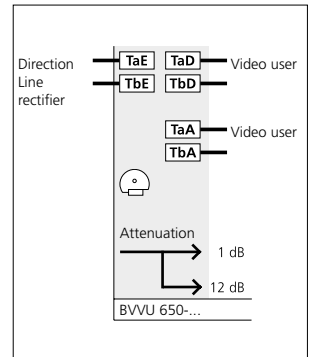

### BVVU 650-... in the monitor branch

Decoupling a video user from a side circuit into the apartment. For more information, see page 46

## 4 Configuration, conductor lengths

### Bus distributor for top hat rail mounting

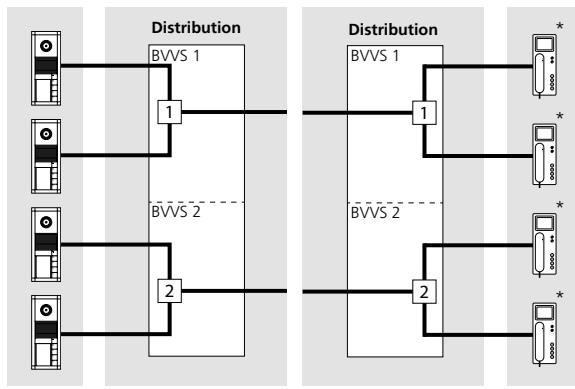

#### **BVVS 652-... in the camera branch:**

More than one video door station in the camera branch with "star shaped" conductor routing.

#### **BVVS 652-... in the monitor branch:**

Within the In-Home bus: Video more than one side circuit is required.

#### **Attenuation:**

The attenuation from BVVS 652-... and the conductor length must be taken into consideration.

\* The device must not be a table-top device, as there is an open cable end in the case of a device that is not plugged in.

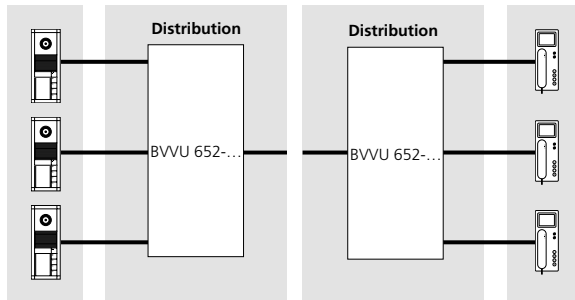

#### **BVVU 652-... in the camera branch:**

More than one video door station in the camera branch with "star shaped" conductor routing.

#### **BVVU 652-... in the monitor branch:**

Connection of a bus telephone with monitor to a side circuit with "star shaped" conductor routing.

#### **Attenuation:**

The attenuation from BVVU 652-... and the conductor length must be taken into consideration.

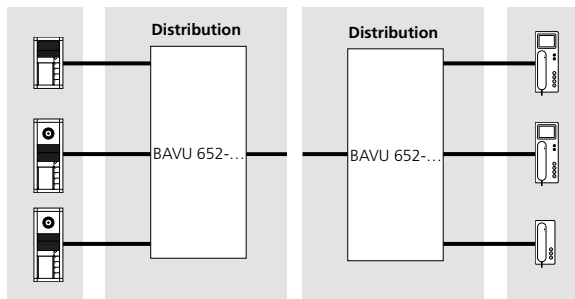

#### **BAVU 652-... in the camera branch:**

More than one video door station in the camera branch with "star shaped" conductor routing.

Connection of audio users (e.g. BTLM 650-... or BTLE 050-...) or users for switching and control functions.

#### **BAVU 652-... in the monitor branch:**

Connection of a bus telephone with monitor to a side circuit with "star shaped" conductor routing.  
Connection of audio users (AIB 150-..., BTS/BTC/BFC 850-..., DCA 650-...) or users for switching and control functions.

#### **Attenuation:**

The attenuation from BAVU 652-... and the conductor length must be taken into consideration.



# Attenuation values

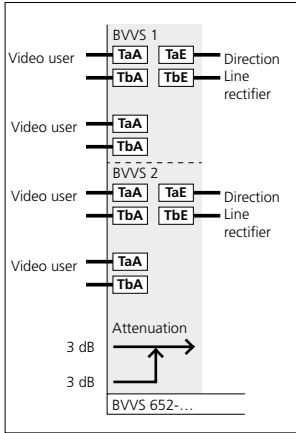

## BVVS 652... in the camera branch

When more than one video door station is operated within a camera branch.

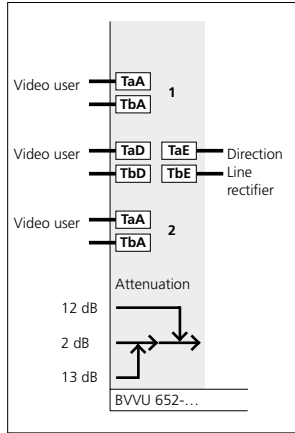

## BVVU 652... in the camera branch

When more than one video door station is operated within a camera branch.

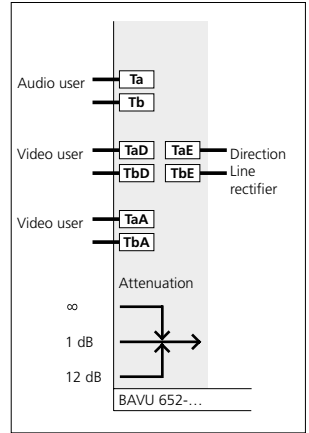

## BAVU 652... in the camera branch

Connection of audio users and for coupling and decoupling video users in a device.

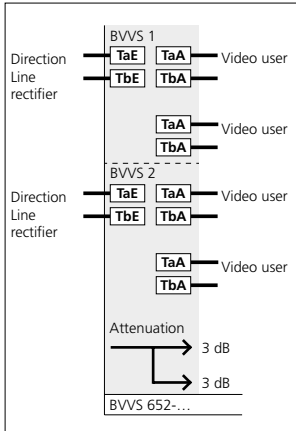

## BVVS 652... in the monitor branch

Within the In-Home bus: Video more than one side circuit is required.

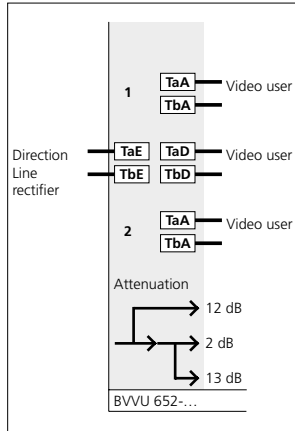

## BVVU 652... in the monitor branch

Connection of a bus telephone with monitor to a side circuit with "star shaped" conductor routing.

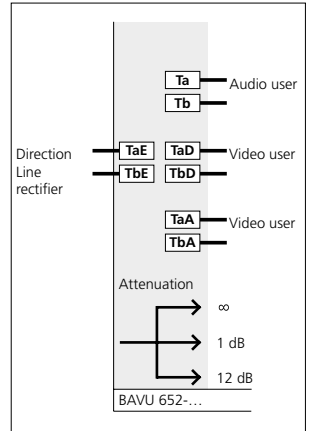

## BAVU 652... in the monitor branch

Connection of audio users and for coupling and decoupling video users in a device.

## 5 In-Home: Video users

### Door loudspeakers, call buttons

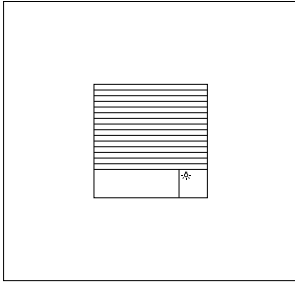

#### BTLM 650-04

Bus door loudspeaker module for In-Home bus. Loudspeaker and microphone integrated, illuminated light button, integrated door release contact (DR) Acoustic acknowledgement on pressing a button, can be activated if required with the BPS 650-... contact load max. 15 V AC, 30 V DC, 2 A, switching time DR fixed at 3 seconds. Acoustic feedback when actuating the call buttons.

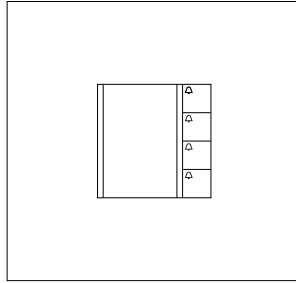

#### BTM 650-01 to -04

Bus call button modules for In-Home bus 1–4 call buttons, integrated LED lighting. Connection by means of ribbon cable to the bus door loudspeaker. Supply to the LED lighting via terminal b and c with 12 V AC, current consumption 20 mA per bus call button module BTM 650-...

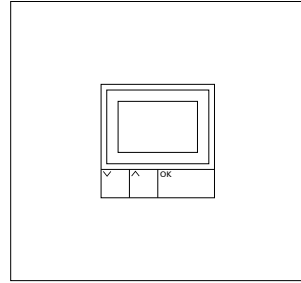

#### DRM 612-02

Display call module as an input device with 4-line display for placing door calls. Indication of names in the display in alphabetical order. The DRM 612-... can also be used in combination with the COM 611-... in order to display the input via the DRM 612-...

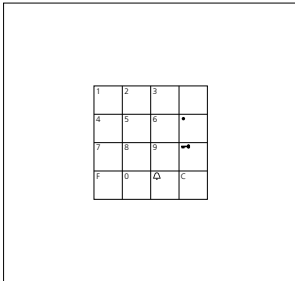

#### COM 611-02

Code lock module as input unit for access control and for making door calls.

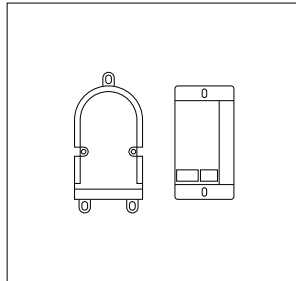

#### BTLE 051-04

Bus custom-fit door loudspeaker with bus call button matrix for installation in the customer's intercom compartments, door constructions, letterboxes, etc. Up to 12 of the customer's call buttons can be directly connected to the BRMA 050-... bus call button matrix.

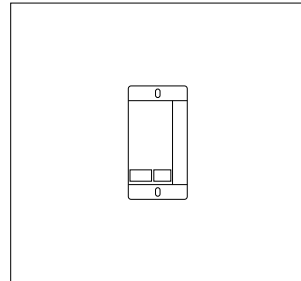

#### BRMA 050-01

Bus call button matrix for connecting 12 on-site call buttons to the BTLE 050-.../ATLE 670-... custom-fit door loudspeaker. Max. 160 call buttons can be connected. However, a bus call button matrix BRMA 050-... is required for each started group of 12 call buttons.

## Door stations

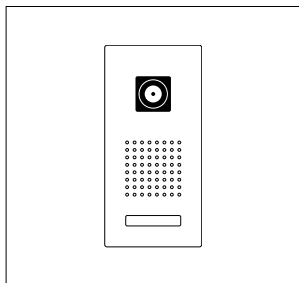

### Siedle Classic

Door station in the Classic design line, with stainless steel front, door loudspeaker, call buttons and Bus camera. LED-illuminated bell buttons, 5 mA, 12 V AC each per button.

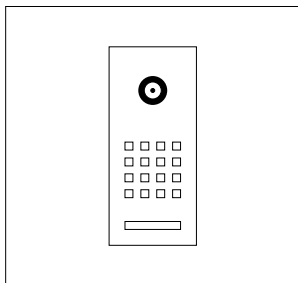

### Siedle Steel

Door station in the Steel design line, with stainless steel front, door loudspeaker, call buttons and Bus camera. LED-illuminated bell buttons, 3 mA, 12 V AC each per button.

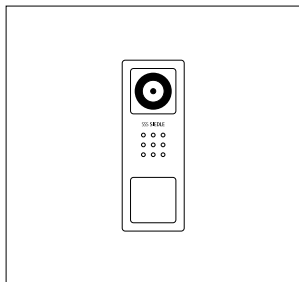

### CV 850-1/2-03 E

Siedle Compact video door station, for installation in the In-Home bus or as a replacement device in the Siedle Basic video set. With the functions calling, speech, vision and door release.

Contact type: contact 24 V, 2 A

Protection system: IP 54, IK 8

Ambient temperature:

-20 °C to +40 °C

Dimensions (mm) W x H x D:

82 x 226 x 35

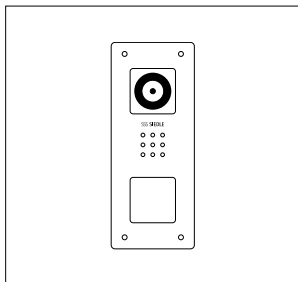

### CVU 850-1/2-0 E

Siedle Compact video door station flush mounting in bus technology, for installation in the In-Home bus. With the functions calling, speech, vision and door release.

Contact type: contact 24 V, 2 A

Protection system: IP 54, IK 8

Ambient temperature:

-20 °C to +40 °C

Dimensions front panel (mm)

W x H x D: 110 x 273 x 1

Dimensions housing (mm)

W x H x D: 85 x 253 x 48

## 5 In-Home: Video users

### Bus and external cameras

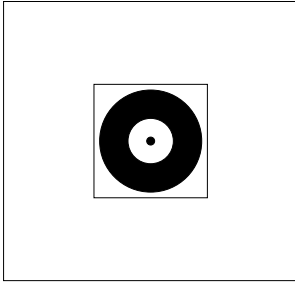

#### **BCMC 650-03**

Bus camera 80 for Siedle Vario with automatic day/night switchover (True Day/Night) and integrated infrared lighting. Horizontal/vertical pick-up angle: appr. 80°/60°

Colour system: PAL

Image pick-up: CMOS sensor 1/3"  
756 x 504 Pixel

Resolution: 550 TV lines

Lens: 2.9 mm

Mechanical adjustment range:

30° horizontal/vertical

2-step heating: 12 V AC

max. 130 mA

Protection system: IP 54, IK 10

Ambient temperature:

-20 °C to +55 °C

Height of structure (mm): 32

Dimensions (mm) W x H x D:

99 x 99 x 58

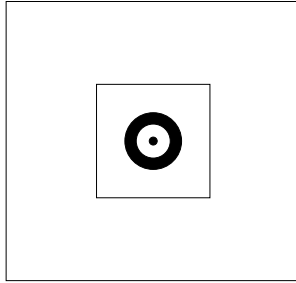

#### **BCM 653-02**

Bus camera 130 for Siedle Vario with automatic day/night switchover (True Day/Night) and integrated infrared lighting. Horizontal/vertical pick-up angle: appr. 130°/100°

Colour system: PAL

Image pick-up: CMOS sensor 1/3"  
756 x 504 Pixel

Resolution: 550 TV lines

Lens: 2.1 mm

2-step heating: 12 V AC

max. 130 mA

Protection system: IP 54, IK 10

Ambient temperature:

-20 °C to +55 °C

Height of structure (mm): 15

Dimensions (mm) W x H x D:

99 x 99 x 41

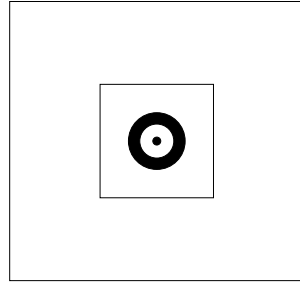

#### **BCM 658-02**

Bus camera 180 for Siedle Vario with automatic day/night switchover (True Day/Night) and integrated infrared lighting. Horizontal/vertical pick-up angle: appr. 175°/120°

Full screen or 9 picture excerpts can be selected

Electronic image rectification in full screen

Extended pick-up angle in edge area for selected picture excerpt

Backlight compensation (BLC)

Colour system: PAL

Image pick-up: CMOS sensor 1/2.7"

1920 x 1080 pixels

Resolution: 600 TV lines

Lens: 1.55 mm

2-step heating: 12 V AC

max. 130 mA

Protection system: IP 54, IK 10

Ambient temperature:

-20 °C to +55 °C

Height of structure (mm): 15

Dimensions (mm) W x H x D:

99 x 99 x 41

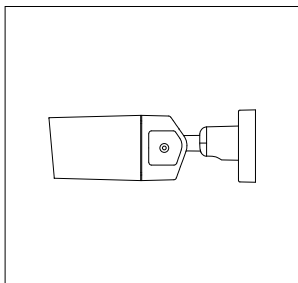

#### **CE 600-01**

Colour CCD video camera external mounting with automatic day/night switchover (True Day/Night) and integrated infrared lighting. Horizontal pick-up angle: appr. 81.2°–22.5°  
Colour system: PAL

Image pick-up: CCD sensor 1/3" 976 x 582 Pixel

Resolution: 750 TV lines

Lens: 2.8–12 mm

Mechanical adjustment range: 160° horizontal/180° vertical

Continuous operation: suitable

Video output: 1 Vss at 75 Ohm

Operating voltage: 20–50 V DC

Operating current: max. 250 mA

Protection system: IP 67

Ambient temperature:

–20 °C to +50 °C

Dimensions (mm) W x H x D:

75.3 x 76 x 218.5

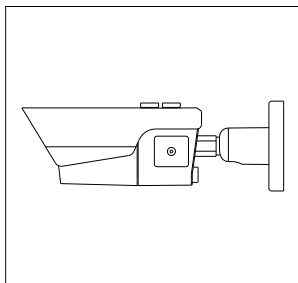

#### **CE 950-01**

Colour CCD video camera external mounting with automatic day/night switchover (True Day/Night) and integrated infrared lighting. Horizontal pick-up angle: ca. 45.6°–4.0°  
Colour system: PAL

Image pick-up: CCD sensor 1/4" 976 x 582 Pixel

Resolution: 700 TV lines

Lens: 3.8–45.6 mm

Mechanical adjustment range: 180° horizontal/vertical

Continuous operation: suitable

Video output: 1 Vss at 75 Ohm

Operating voltage: 20–50 V DC

Operating current: max. 500 mA

Protection system: IP 67

Ambient temperature:

–20 °C to +50 °C

Dimensions (mm) W x H x D:

100 x 108 x 267

## 5 In-Home: Video users

Bus distributor, Bus video modulator

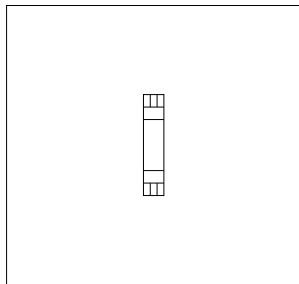

### BAVU 652-0

Asymmetrical bus audio/video distributor for top hat rail mounting for connection of pure audio components and for decoupling/coupling the In-Home bus: Video users in one device.

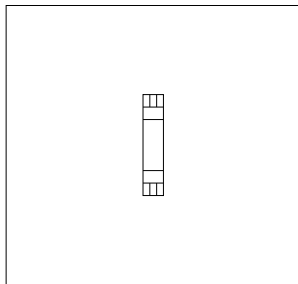

### BVVU 652-0

Asymmetrical bus video distributor for top hat rail mounting comprising 2 internally linked distributors for decoupling/coupling the In-Home bus: Video users.

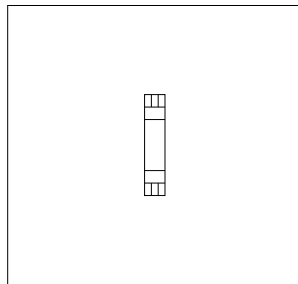

### BVVS 652-0

Symmetrical bus video distributor for top hat rail mounting comprising 2 completely separate distributors with 2 outputs each for creation of a tree structure or in the case of several risers.

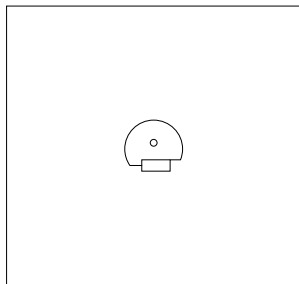

### BAA 650-0

Bus audio decoupling for connection of audio users such as AIB 150-..., BTS/BTC/BFC 850-..., DCA 650-... or switching and control devices within In-Home: Video. Screw terminals for bus input, looped bus throughput and connection of audio users.

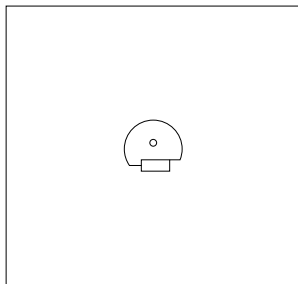

### BVVU 650-0

Asymmetrical bus video distributor for coupling/decoupling In-Home: Video users. Screw terminals for bus input, looped bus throughput and bus output.

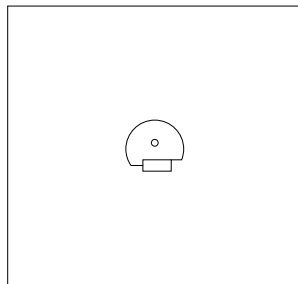

### BVVS 650-0

Symmetrical bus video distributor with 2 outputs, suitable for mounting in a 55 junction box, for creation of a tree structure or in the case of several risers.

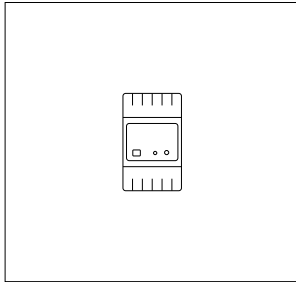

### **BVM 650-0**

The bus video modulator in switch panel housing connects an analogue camera with the In-Home bus.

There are two operating modes to choose from, the analogue camera can be operated with or without a door station. A distance of up to 100 m between the camera and the BVM 650-... is permitted. Supply via the In-Home bus. A potential-free switching contact, e.g. for camera or light actuation, is available.

Contact type: potential-free

max. 30 V AC/DC, 1 A

Protection system: IP 20

Ambient temperature:

0 °C to +40 °C

Horizontal pitch (HP): 3

Dimensions (mm) W x H x D:

53.5 x 89 x 60

## 5 In-Home: Video users

### Power supply, line rectifiers

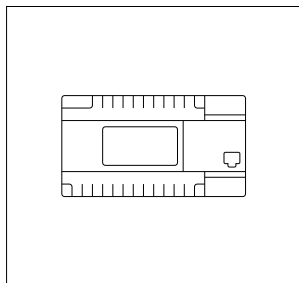

#### **BVNG 650-0**

Bus video line rectifier in a 9-grid housing.

Primary: 230 V AC, 50/60 Hz,  
door release contact 15 V AC,  
30 V DC, 2 A, switching time fixed  
at 3 seconds.

Light contact 15 V AC, 30 V DC,  
2 A, switching time 0.4 seconds,  
modification possible using bus pro-  
gramming software BPS 650-...

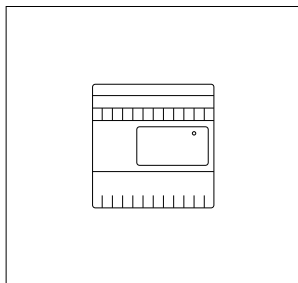

#### **NG 706-30/33-0**

Line rectifier in switch panel housing  
for central supply of Siedle system  
components.

Operating voltage: 230 V AC,  
+/-10 %, 50/60 Hz

Operating current: 250 mA

Output voltage: 30 V DC

Output current: 1.1 A

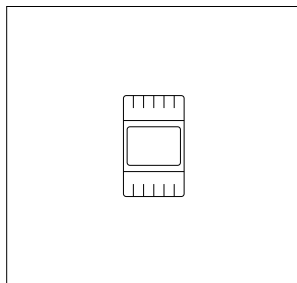

#### **TR 603-0**

Transformer in a 3-grid housing.

Primary: 230 V AC, 50/60 Hz

Secondary: 12 V AC, 1.3 A

Supply to the LED lighting of the bus  
call button module, door release or  
heating for the bus camera.

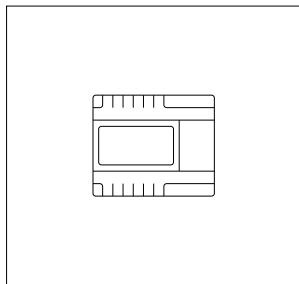

#### **NG 602-01**

Bus line rectifier in a 6-grid housing.

Primary: 230 V AC, 50/60 Hz

Secondary: 12 V AC, 1.6 A and  
23.3 V DC - 0.3 A stabilized.

For additional power supply to a  
VIB 150-..., BTSV/BTCV 850-... in  
case of parallel door calls.

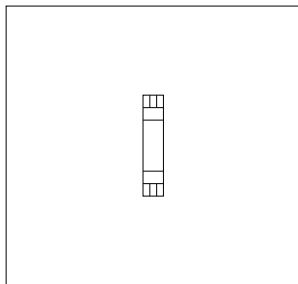

#### **PSM 1 12 24**

Line rectifier in switch panel housing  
for central supply of IQ in-house  
telephones and the bus video panel.

One PSM 1 12 24 supplies a max-  
imum of 2 IQ in-house telephones  
or 1 bus video panel. In systems with  
bus video panel, a maximum of 2  
PSM may be used.

Operating voltage: 110-240 V AC,  
50/60 Hz

Operating current: 265 mA

Output voltage: 24 V DC +/-3 %

Output current: 0.5 A



## Switching, controlling, converting

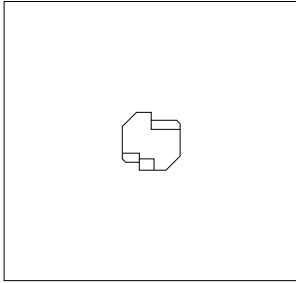

### **BSE 650-01**

Bus switching unit with bistable relay, suitable for mounting in a 70 junction box.  
Actuation possible via BEM, using the programmable buttons of the system users or in parallel to a door call button.

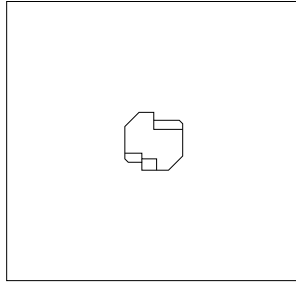

### **BEM 650-02**

Bus input module for mounting in a 70 junction box with an input for tripping switching functions/transmitting messages at the In-Home bus.  
Activation possible via potential-free contact or 4–30 V DC, 10 mA.

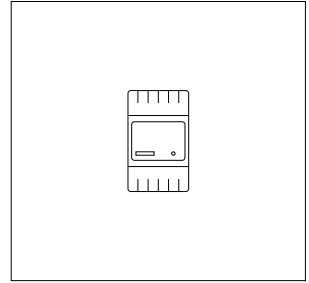

### **BSM 650-02**

Bus switching module in 3-grid housing. 4 integrated relays, each with a potential-free working contact. Actuation via the call buttons of the bus telephones or light button at the door station. Relay functions as a timer between 0.4 seconds and 12 seconds. Max. contact load 15 V AC, 30 V DC, 2 A. 12 V AC supply required, 250 mA.

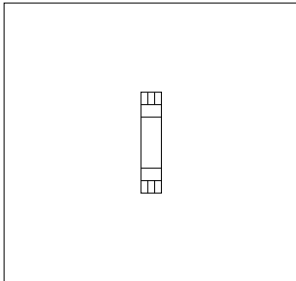

### **BSE 651-0**

Bus switching unit for the top hat rail, with bi-stable relay.  
For implementing various switching scenarios.  
Actuation possible via BEM bus input module, the function buttons of the bus telephones (incl. door release button) or the light or call button of a door station.

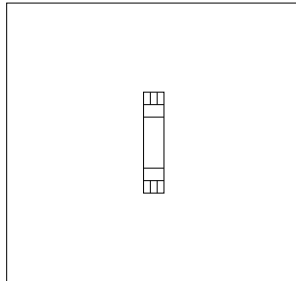

### **BEM 651-0**

Bus input module for the top hat rail. With one input for triggering switching functions or leaving messages on the In-Home bus.  
Activation possible via potential-free contact or 4–30 V DC, 10 mA.

**For connection of BSM/BSE/BEM 650-... to the In-Home bus: Video, the BAA 650-... is required.**

## 5 In-Home: Video users

Switching, controlling, converting

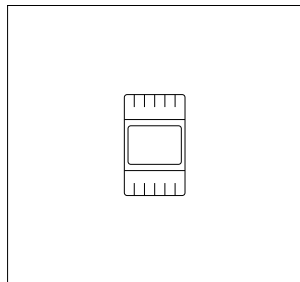

### **BIM 650-02**

Bus interface module in switch panel housing, used for connection between Siedle Vario bus and Siedle In-Home bus.

It is always required when a bus door loudspeaker has to be equipped with a COM or DRM in addition to or instead of direct call buttons.

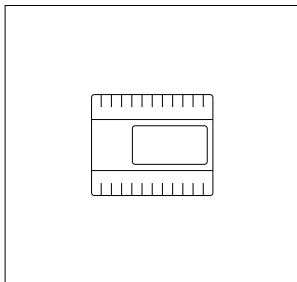

### **BVD 650-0**

The bus video demodulator in a 6-grid switch panel housing converts the video image at the bus cores of the In-Home bus: video into a standard FBAS video signal.

The converted video image can subsequently be transmitted to any video monitor or any TV with a suitable input or can be further processed in a video system.

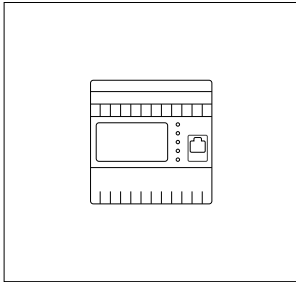

**SG 150-0**

Smart Gateway: top hat rail device for private or professional use. Interface between In-Home bus and IP networks in housing for mounting on DIN top hat rails: Call, speech and video signals from the In-Home bus are transferred to the IP network.

Highlights

- Mobile door call using smartphone app via the Siedle server (cloud service)
- Flexible expansion options for In-Home system with IP clients
- Siedle Axiom and JUNG TCM client can be used without user licence

Other performance features

- Support for the Siedle app for iPhone or Android smartphone
- Up to 10 IP users (subject to licence, 5 licences included)
- Group call of up to 6 IP users
- Parallel call to IP and In-Home bus end devices possible
- Direct door dialling from list
- Central video memory (data protection compliant)
- Connection of the Smart Control Panel from Albrecht Jung GmbH & Co. KG
- Connection of VoIP telephones (subject to licence)
- CTI door call (subject to licence)
- Connection of TC systems (subject to licence)

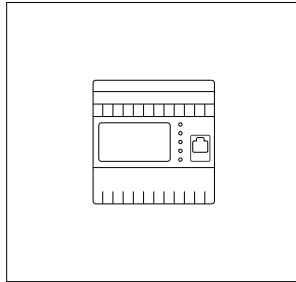

**SG 650-0**

Smart Gateway Professional: top hat rail device for private or professional use. Interface between In-Home bus, IP networks, the internet and mobile phone network: Call, speech and video signals from the door are transmitted to the IP network.

Highlights

- Mobile door call using smartphone app via the Siedle server (cloud service)
- Flexible expansion options for In-Home system with IP clients
- Siedle Axiom and JUNG TCM client can be used without user licence

Other performance features

- Support for the Siedle app for iPhone or Android
- Up to 50 IP users (subject to licence, 2 licences included)
- Group call of up to 6 IP users
- Parallel call to IP and In-Home bus end devices possible
- Direct door dialling from list
- Central video memory (data protection compliant)
- Connection of the Smart Control Panel from Albrecht Jung GmbH & Co. KG
- Connection of VoIP telephones
- CTI door call
- Connection of TC systems (subject to licence)

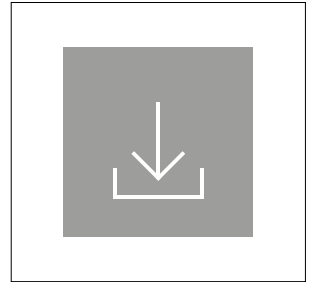

**BSHT 650-0**

The virtual in-house telephone assumes the function of a video indoor station as the client software on a Windows PC or a Windows-based operating panel.

Performance features:

- Control directly at the monitor by mouse click or fingertip pressure
  - Two view modes: Window and widget view
  - Audio and video door communication
  - Camera surveillance
  - Video memory
  - Direct door dialling from list
  - Receiving group calls
  - Switching and control functions (e.g. for door opening and light switching)
- Available for the Smart Gateway Professional (SG 650-0)
- Subject to licence, 2 licences for Smart Gateway Professional (SG 650-0) included
  - CTI door call: Audio transmission via the telephone network in parallel with the video signal possible over Ethernet, ensuring an audio link in optimum TC quality

## 5 In-Home: Video users

Gateway, Software, License, PC interface, DoorCom

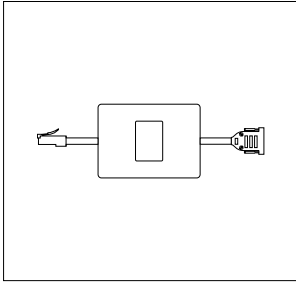

### PRI 602-0

Programming interface for connection of a Windows PC via serial interface to the Vario bus. The Vario bus is programmed using programming software PRS 602-..., provided with the delivery. If the BIM 650-... is additionally used, the In-Home bus can also be programmed.

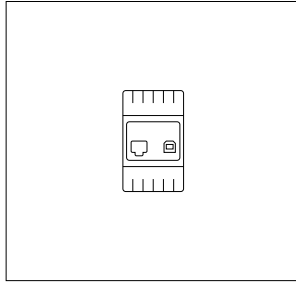

### PRI 602-01 USB

Programming interface for connection of a Windows PC via USB port to the ZBVG 650-... interface. The ZBVG 650-... is plugged into bus line rectifier BNG/BVNG 650-... Commissioning, programming and servicing facility for the In-Home bus using BPS 650-... software.

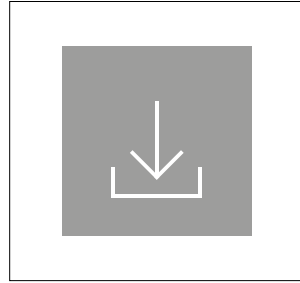

### BPS 650-0

Bus programming software for programming In-Home bus systems. For this, the programming interface PRI 602-... is also required in conjunction with a BIM 650-... or the PRI 602-... USB.

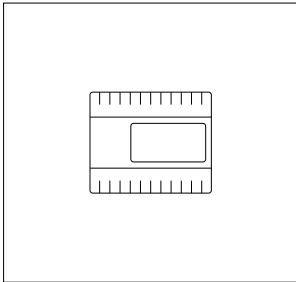

### DCA 650-02

DoorCom-Analog for connection of one or more door stations to an analogue PBX extension of a telephone system. Up to 31 call numbers can be stored.

The call can be made using bell buttons or the display call module from the door station. Power supply with 12 V AC to terminals b and c, connection to the In-Home: Video only via BAA 650-...

### BLC 250-0

Licence for an additional IP user at the Smart Gateway. Purchase orders can be placed via the "My Siedle" service portal: [www.siedle.com/mysiedle](http://www.siedle.com/mysiedle)

The licence is linked to the hardware. If a Smart Gateway fails, Siedle transfers all purchased licences free of charge to an identical substitute device (investment protection).

## Bus indoor devices

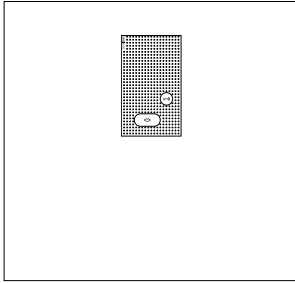

### **AIB 150-01**

Audio indoor station Siedle Basic: Handsfree station for surface mounting.

Entry-level device with all essential functions in the accustomed standard of Siedle quality. Minimized ergonomically optimized design with simple operation, clear symbolism and excellent acoustics.

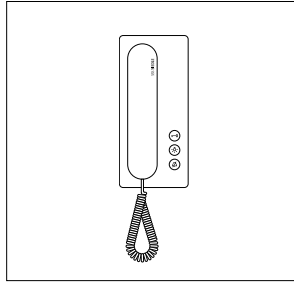

### **BTS 850-02**

Standard bus telephone. Connection at bus cores Ta and Tb.

Functions:

- Calling, speech, door release and storey call
- Door release and light button
- Internal speech communication
- 11 ringtones
- Call and voice volume adjustable in 5 steps
- Muting button for ringtone
- Double assignment of the light button and silencing button possible.
- Integration of ZAR 850-... accessory possible

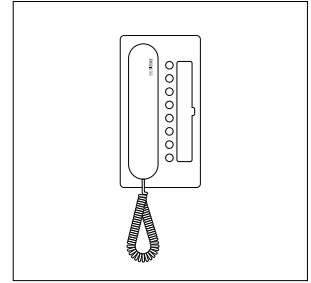

### **BTC 850-02**

Deluxe bus telephone. Connection at bus cores Ta and Tb.

Functions:

- Calling, speech, door release and storey call
- Door release and light button
- Internal speech communication
- 11 ringtones
- Call and speech volume can be changed in 5 steps
- Silencing button for the ringtone
- 7 keys for switching and control functions with double assignment facility
- 7 LEDs under the buttons for display of switching statuses
- Integration of ZAR/ZPS 850-... accessory possible

## 5 In-Home: Video users

### Bus indoor devices

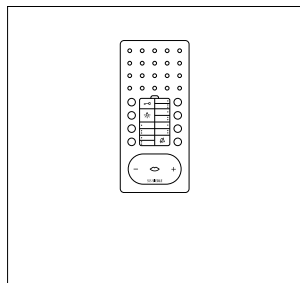

#### **BFC 850-0**

Deluxe handsfree bus telephone intercom. Connection at bus cores Ta and Tb.

Functions:

- Calling, handsfree/simplex communication, door release and storey calls
- Speech/control button
- Door release and light button
- Internal speech communication
- 11 ringtones
- Call and speech volume can be modified in 5 stages
- Muting button for the ringtone
- 7 keys for switching and control functions with double assignment facility
- Additional intercomfunctions possible (from V 4.0)
- Integration of ZARF/ZPSF 850-... accessory possible

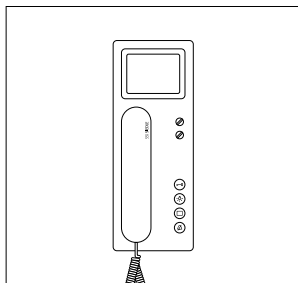

#### **BTSV 850-03**

Standard bus telephone with colour monitor for Siedle in-home bus Functions:

- Calling, speech, vision, door release and storey call
- Colour monitor 8.8 cm
- Door opener and light button
- Mute button for call tone
- 11 call tone melodies
- Monitor button for current picture
- Brightness and colour regulation

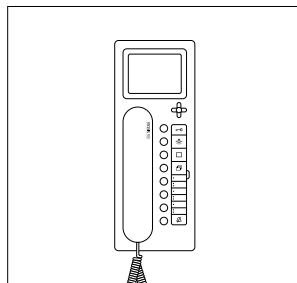

#### **BTCV 850-03**

Comfort bus telephone with colour monitor for door and internal telephony.

Functions:

- Calling, speech, vision, door release and storey calls
- Colour monitor 8.8 cm
- Integrated video memory for 28 pictures, upgradable with SD card
- Door release and light button
- Keys for switching and control functions
- Internal speech communication
- display of switching statuses
- Silencing button for the ringtone
- 11 ringtones
- Call and speech volume can be modified in 5 stages
- Monitor button for current picture
- 5-way button for video memory and zoom function
- Video memory function (only with additional installation)

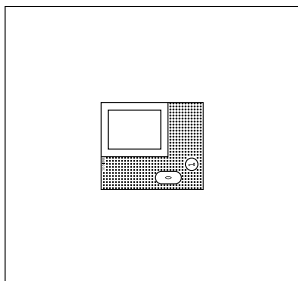

### **VIB 150-0**

Video indoor station Siedle Basic:  
Video handsfree station for surface  
mounting.

Entry-level device with all essen-  
tial functions in the accustomed  
standard of Siedle quality. Minimized  
ergonomically optimized design  
with simple operation and clear  
symbolism, excellent acoustics and  
image reproduction.

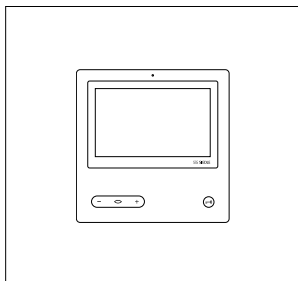

### **BVPC 850-0**

Deluxe bus video panel with  
touchscreen 17.8 cm for the Siedle  
In-Home bus.

Functions:

- Calling, speech, vision, door  
release, light, storey call/switching/  
control functions, signal displays and  
internal communication
- Integrated video memory, capacity  
for over 2000 images with the sup-  
plied SD card (4 GB)
- 15 switching/control functions in  
conjunction with the bus switching  
module BSM/BSE 650-...
- 15 signal displays
- Optimized depiction of switching/  
control functions and messages
- Voice volume adjustable in  
5 stages
- 11 different electronic call tones to  
choose from
- Optical call display by flashing of  
the speech button
- Selective dialling of max. 15 door  
loudspeakers/cameras
- Call silencing and status display
- Call volume adjustable in 5 stages  
up to max. 83 dB(A)
- Door release/light function at any  
time using bus cores
- Door/video connection possible at  
any time
- Feedback for switching/control  
functions and messages in con-  
junction with bus input module  
BEM 650-...
- Internal telephony with  
max. 15 indoor stations
- Call forwarding

- Collective announcement  
(from V 4.0)
- Automatic call pick-up of internal  
calls

## 5 In-Home: Video users

### Jung indoor stations

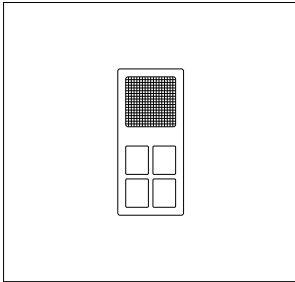

#### SI 4 A ..

Audio indoor station standard  
Audio indoor station design standard  
Calling, speech, door release, light,  
storey call, switching/control func-  
tions and internal communication.

- Polarity reversal-proof 2-wire installation
- Connection for Siedle In-Home bus
- Connection for storey call button
- Call generator with 11 call tone sequences, including chime
- Muting and status display

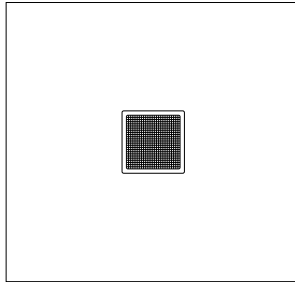

#### SI AM ...

The audio module is the basic  
module of the modular structured  
flush mounted indoor station. This  
is where the Siedle In-Home bus is  
connected. If no call button module  
or video module is connected, the  
audio module functions as a sec-  
ondary signal unit (bell).

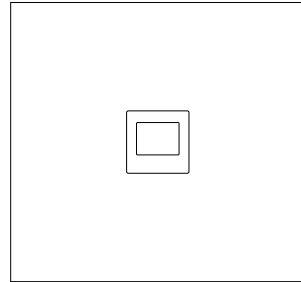

#### SI VM ...

The video module has a TFT colour  
monitor with a screen diagonal of  
70 mm (2.7") in the LS and CD  
series / 55 mm (2.2") in the A series  
with 320 x 240 pixel.

The video module is supplied  
including the video connecting cable  
(black, 220 mm).

Operation is only possible in con-  
junction with universal call button  
module and audio module.

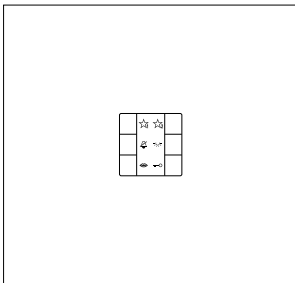

#### SI TM .. 5073

The standard call button module has  
5 LEDs for display (e.g. door open)  
without additional wiring, one ready  
status using LED and one optical call  
display by means of a flashing LED at  
the speech button.

The standard call button module is  
supplied including inscription film for  
audio / video and audio connecting  
cable (red, 220 mm).

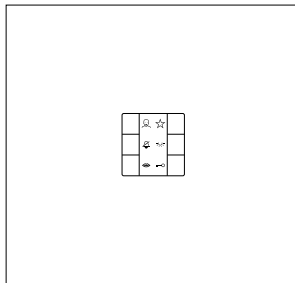

#### SI TM .. 5093

The universal call button module has  
5 LEDs for display (e.g. door open)  
without additional wiring, one ready  
status using LED and one optical call  
display by means of a flashing LED at  
the speech button.

The universal call button module  
with inscription field capable of  
illumination is supplied including  
inscription film for audio / video  
and audio connecting cable (red,  
220 mm).

The universal call button module  
has one terminal for a supplement-

ary power supply. This is required  
for operation of a video module,  
illumination of the inscription field  
in the universal call button module,  
and when connecting a second  
call button module. An additional  
call button module (standard or  
universal, max. 2 call button mod-  
ules per indoor station) can be  
connected.



## Table-top accessory

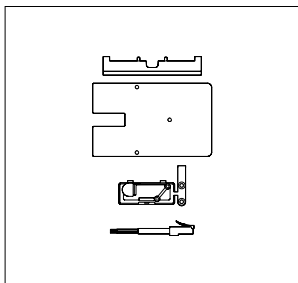

### ZTS 800-01

Standard table-top accessory for bus telephones BTS/BFC 850-... for conversion from a wall-mounted to a table-top unit. Connection of the table top unit to an 8-pin telecom socket type UAE 8(8).

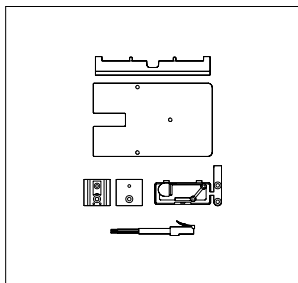

### ZTC 800-0

Deluxe table-top accessory for the bus telephone BTC 850-... for conversion from a wall to a table top unit. Connection of the table top unit to an 8-pin telecom socket type UAE 8/8(8).

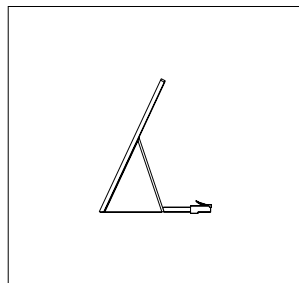

### ZTCV 850-0

Table-top accessory for bus telephones with colour monitor BTCV 850-... as well as BTSV 850-03 for conversion from a wall to a table-top unit. Slip-proof console with 2 rubber feet but without telecom socket UAE 8(8).

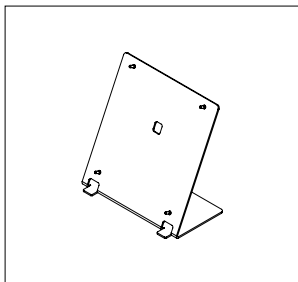

### ZTVP 850-0

Table-top accessory for the BVPC 850-... bus video panel for conversion from a wall to a table-top device.

Slip-proof table foot, connecting cable with RJ45 plug, but without telecom socket UAE 8(8).

## 5 In-Home: Video users

### Accessory

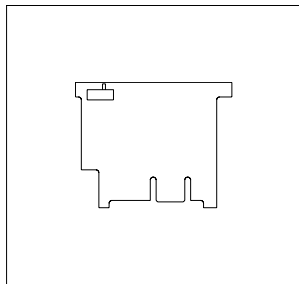

#### **ZBVNG 650-0**

Bus video line rectifier accessory as a plug-in card for installation in bus video line rectifier BVNG 650-...

Required where attenuation within a line is > 45 dB or for the creation of a multiple-line system with more than one BVNG 650-...

In the case of multiple line systems, the ZBVNG 650-... must be installed in each BVNG 650-...

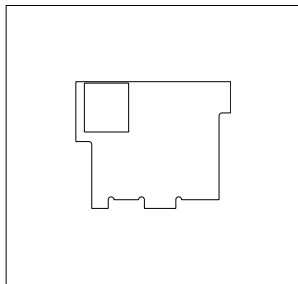

#### **ZBVG 650-0**

Bus supply unit accessory as a plug-in card for integration in bus line rectifier BNG 650-... or bus video line rectifier BVNG 650-... with 8-pin Western socket for connection of the programming interface PRI 602-... USB.

Is required in systems with more than one line or for programming the in-home bus via a Windows PC and PRI 602-... USB. Only one unit may be installed within the Siedle In-Home bus.

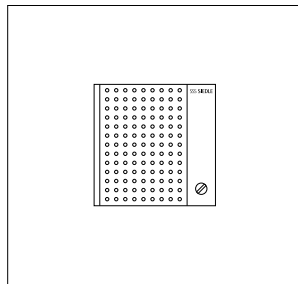

#### **BNS 750-02**

Bus secondary signal unit, for signalling door and storey door calls in another room or corridor. Connection to In-Home bus: Audio Call volume steplessly adjustable up to max. 86 dB(A). Call differentiation for door calls and storey calls.

Connection to the In-Home: Video only via BAA 650-...

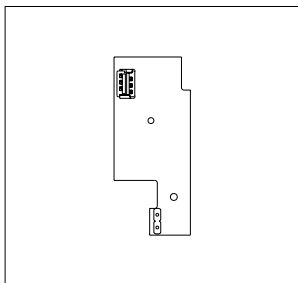

#### ZPS 850-0

Parallel switching accessory for integration into deluxe bus telephone BTC 850-... Circuit board for connection of an additional power supply. Required in case of manual programming from the third BTC 850-..., with PC programming from the fifth BTC 850-... Supply 20–30 V DC from NG 602-... or NG 706-30/33-..., current consumption max. 100 mA

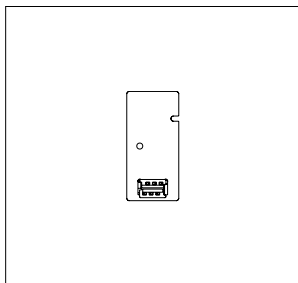

#### ZARF 850-0

Handsfree interfacing relay accessory for integration in the handsfree bus telephone BFC 850-... Universal switching relay e.g. for secondary signal unit, video actuation or switching relay.  
Contact type: Contact 15 V AC, 30 V DC, 2 A  
Switching time: 0.4 sec to 19 min programmable using the bus programming software BPS 650-... V2.x

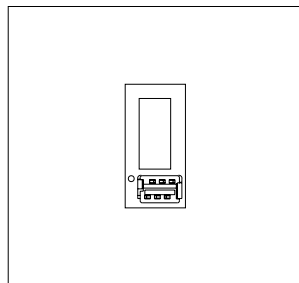

#### ZPSF 850-0

Parallel switching accessory for integration into deluxe handsfree bus telephone BFC 850-... Circuit board for connection of an additional power supply. When programming manually, required from the third BFC 850-..., when programming by PC from the fifth BFC 850-... Supply 20–30 V DC from NG 602-... or NG 706-30/33-..., current consumption max. 100 mA. Required for the function parallel door call, collective paging announcement/internal group call to more than 2 bus telephones. When programming with BPS 650-... 4 bus telephones.

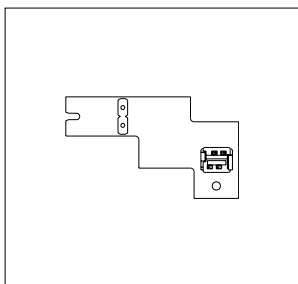

#### ZAR 850-0

Interfacing relay accessory for mounting in bus telephones BTS 850-... or BTC 850-... Universal switching relay with a potential-free contact for secondary signal unit, video interfacing or switching relay, one potential-free switching contact.  
Contact type: Contact 15 V AC, 30 V DC, 2 A  
Switching time: 0.4 sec to 19 min programmable using the bus programming software BPS 650-... V2.x

## 6 Installation

### General information

#### Installation

In each bus indoor device with colour display, there is a terminating circuit board connected in the as-delivered status in the centre of the connecting terminals TaM and TbM. This circuit board is an RC element which comprises a resistor with 100 Ohm and a capacitor 1 nF. When looping through from one bus indoor device to the next bus indoor device in the installation, this terminating circuit board must be removed. If, however, bus distributors are used in the installation, or if there is only 1 bus indoor device with colour display in the line, the terminating element remains in the bus indoor device.

#### Terminal VIB 150-..., BTSV/BTCV/ BVPC 850-...

Connection for one bus indoor device or the last bus indoor device in the line.

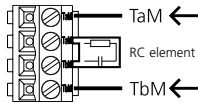

Connection when looping through from one bus indoor device to another bus indoor device.

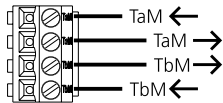

#### Cable laying

Only signals from the In-Home bus may be transmitted via the laid conductor material. No additional transmission is possible, for instance to PBX extensions of a telephone system or an S0 bus (ISDN). The camera branch and monitor branch must be laid in a separate cable and must not be installed inside the same conduit. This can result in disturbance to the picture composition.

Consumers	Voltage	Current
Door release	12 V AC	appr. 600 mA
Camera heating	12 V AC	130 mA
Vario bus call button module (BTM 650-01 to -04)	12 V AC	max. 20 mA
Steel button illumination	12 V AC 10–30 V DC	max. 3 mA
Classic button illumination CL ...-01	12 V AC 10–30 V DC	max. 25 mA max. 30 mA
Classic button illumination CL ...-02	12 V AC 10–30 V DC	max. 5 mA

Models	Terminal assignment	Voltage	Current
BVNG 650-...	TaK, TbK	29 V DC	1200 mA
	TaM, TbM	29 V DC	1200 mA
BNG 650-...	Ta, Tb	27.5 V DC	500 mA
	b, c	12 V AC	1000 mA
NG 602-...	+, -	23.3 V DC	300 mA
	b, c	12 V AC	1600 mA
TR 603-...	b, c	12 V AC	1300 mA
TR 602-...	b, c	12 V AC	2500 mA
NG 706-30/33-...	+, -	30 V DC	1100 mA
PSM 1 12 24	+, -	24 V DC	500 mA

#### Note

As in the as-delivered/de-energized status, the contact position of the bistable relay (contact S1/S1) cannot be defined, the bus supply to the device must be connected beforehand to ensure that the bistable relay functions correctly.

## Bus call button module, bus video line rectifier

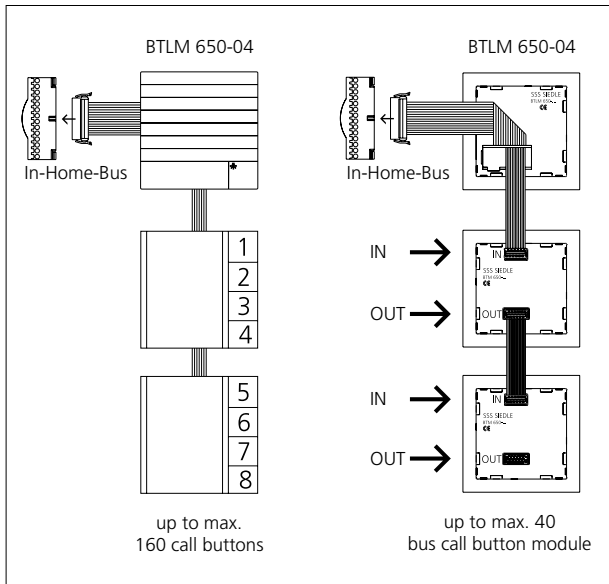

### Bus call button module

Connection of the bus call button modules to the bus door loud-speaker via ribbon cable. The name plate lighting is supplied from the terminal block of the BTLM 650-04. The number of bus call button modules which can be illuminated depends on the overall load of the TR 603-... (1,3 A).

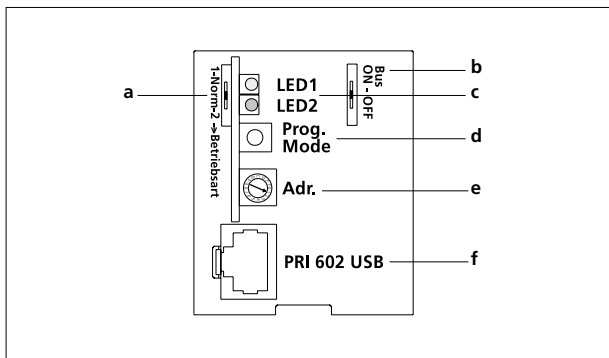

### Bus video line rectifier

At BVNG 650-0, the **operating mode selector switch** must be set to Norm in a new system (as-delivered status). If bus telephones from the predecessor series are used within the line, (e.g. BTS/BTC 750-02 with bus video receiver BVE 650-...), the operating mode switch must be set to 1.

For more information, see page 136

The address is set at the bus video line rectifier using the **"Addr."** rotary switch. In single line systems, this is address 1 in the as-delivered status. This setting does not need to be altered. In multiple-line systems, the bus video line rectifiers are addressed in consecutive sequence.

- |          |   |  |
|----------|---|--|
| <b>a</b> | 1   | = Reverse compatible (with BVSG 650-...) |
|          | Norm  | = Operation as a new system              |
|          | 2   | = Increased range mode                   |
| <b>b</b> | In-Home bus: Video can be switched on and off.  |  |
| <b>c</b> | LED 1   | = Operational LED                        |
|          | LED 2   | = Error LED                              |
| <b>d</b> | Button for programming mode ON/OFF.   |  |
| <b>e</b> | Address setting from 1-15 (1-F) required in multiple-line systems.                      |  |
| <b>f</b> | Socket for connection of PRI 602-... USB, only available if ZBVG 650-... is plugged in. |  |

## 6 Installation

### Modular Jung indoor station

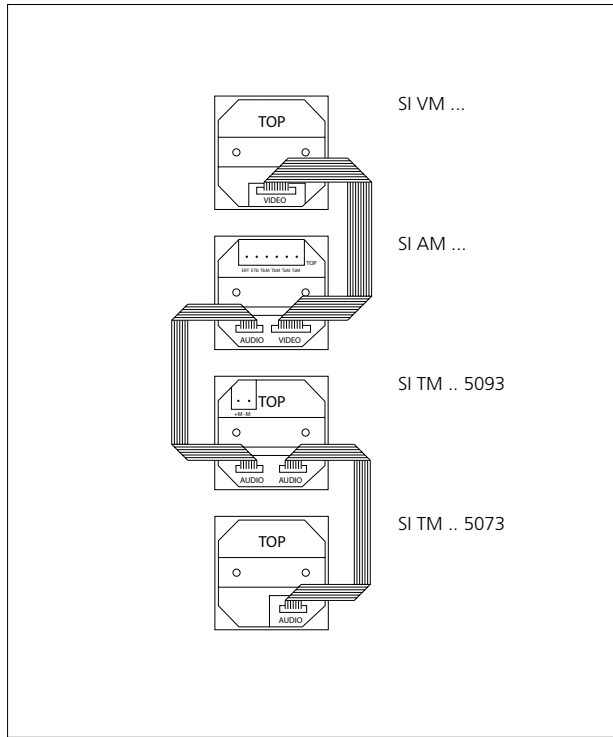

Every module is mounted in a flush-mounting junction box in compliance with DIN 49073. We recommend using a deep junction box for mounting. Mounting takes place using the provided support rings. Mounting can take place in combination or individually – horizontally or vertically.

The modules are interconnected using the supplied connecting cables.

Connection to the In-Home bus takes place at the audio module. The universal call button module has one terminal for a supplementary power supply. This is required for operation of a video module, illumination of the inscription field in the universal call button module, and when connecting a second call button module. An additional call button module (standard or universal, max. 2 call button modules per indoor station) can be connected.

#### SI AI ... Audio indoor station

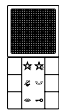

#### Item no.

SI AM ...

SI TM .. 5073

#### Item designation

Audio module

Standard call button module

#### SI VI ... Video indoor station

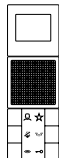

SI VM ...





















SI AM ...

SI TM .. 5093

Video module

Audio module

Universal call button module

Audio combinations	Item no.	Item designation
 	SI AM ...	Audio module
	SI TM .. 5073	Standard call button module
 	SI AM ...	Audio module
	SI TM .. 5093	Universal call button module
  	SI AM ...	Audio module
	SI TM .. 5093	Universal call button module
	SI TM .. 5073	Standard call button module
  	SI AM ...	Audio module
	SI TM .. 5093	Universal call button module
	SI TM .. 5093	Universal call button module
<b>Video combinations</b>		
  	SI VM ...	Video module
	SI AM ...	Audio module
	SI TM .. 5093	Universal call button module
   	SI VM ...	Video module
	SI AM ...	Audio module
	SI TM .. 5093	Universal call button module
	SI TM .. 5073	Standard call button module
   	SI VM ...	Video module
	SI AM ...	Audio module
	SI TM .. 5093	Universal call button module
	SI TM .. 5093	Universal call button module

## 6.1 Installation video

Siedle Vario with BVPC 850-0

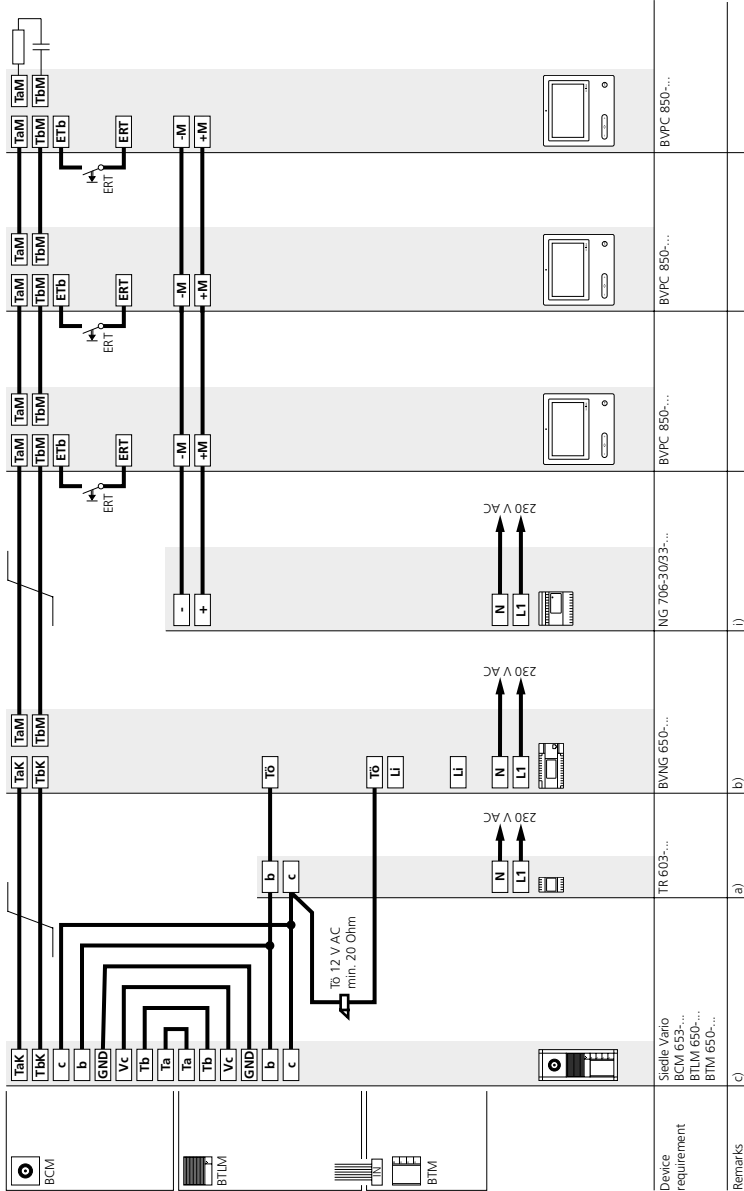



## Siedle Vario with BVPC 850-0

### Functional

Calling, speech and video functions between door station and the connected bus indoor devices with colour display.

Audio and video privacy of existing calls from other bus indoor devices is assured. Door release button for the door release function, light button for the light switching function. Pressing the monitor button will show the camera picture from the door station which placed the last door call. This function is only possible if no call exists.

Connection of a storey call button (ERT) for calling from an apartment door. Ringtones can be selected for calls from the front door, apartment door or internal calls.

Other bus door loudspeakers with video are connected with bus video distributors BVVU 650-... or BVVS 650-...

### Supplementary functions

• **Internal speech communication** between bus indoor devices is only possible internally within the same line.

• **Connection of bus telephones** AIB 150-.../BTS/BTC/BFC 850-... or devices for switching and control functions via bus audio decoupler BAA 650-...

For more information, see page 64

• **Switching and control functions** are possible with the bus switching modules BSM/BSE/BEM 650-..., feedback to the deluxe bus indoor devices can be programmed.

For more information, see page 123

• **Bus secondary signal unit** BNS 750-... possible.

For more information, see page 132

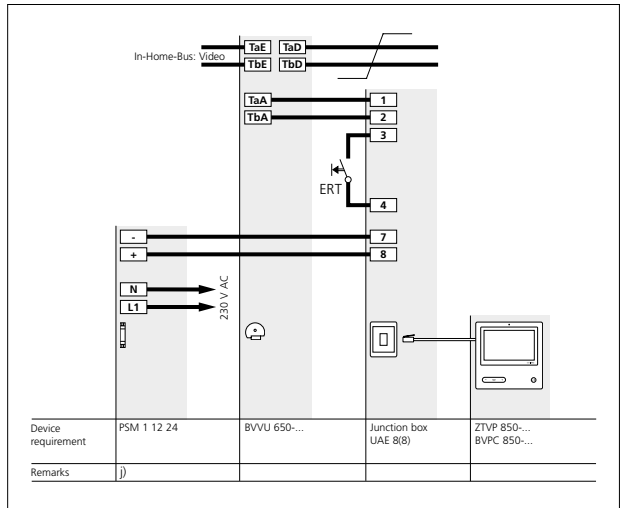

### • Parallel door and storey call

Up to 8 bus indoor devices with colour display can be called simultaneously via one call button. From the second bus telephone VIB 150-.../BTSV/BTCV 850-... each device must be additionally supplied at terminals +M/-M.

Only possible within a line.

Every bus video panel must have its own separate supply.

• **Selective dialling of the door station** possible via additional free buttons.

### Remarks

**a)** The TR 603-... (12 V AC, 1.3 A) can supply the door release, camera heating and max. 30 bus call button modules.

Where more bus call button modules are used, an additional TR 603-... is required for the door release.

**b)** Door release/light contact load in the bus video line rectifier BVNG 650-... max. 15 V AC, 30 V DC, 2 A.

**c)** Door release 12 V AC, use at least 20 Ohm (e.g. TÖ 615-...).

For more information, see page 126

**i)** One NG 706-30/33-... supplies max. 3 BVPC 850-... devices

For more information, see page 129

**j)** In systems with BVPC 850-..., a maximum of 2 PSM may be used.

## 6.1 Installation video

Siedle Vario with SG 150/650-0

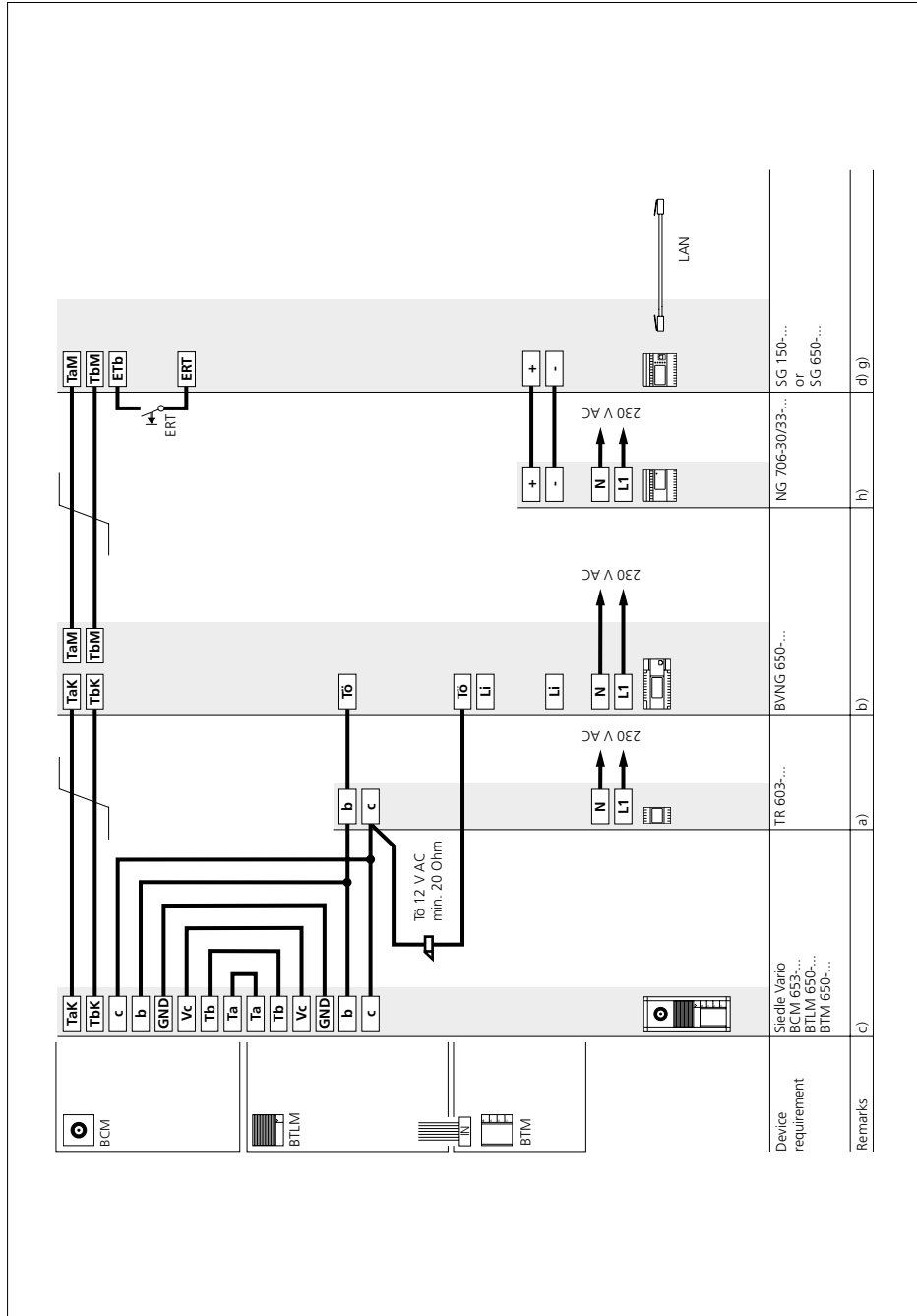

## Siedle Vario with SG 150/650-0

### Functional

Calling, speech and video functions between door station and the connected bus indoor devices with colour display.

Audio and video privacy of existing calls from other bus indoor devices is assured. Door release button for the door release function, light button for the light switching function.

Connection of a storey call button (ERT) for calling from an apartment door. Ringtones can be selected for calls from the front door, apartment door or internal calls.

### Supplementary functions

- **Internal speech communication** between bus indoor devices is only possible internally within the same line.

- **Connection of bus telephones** AIB 150-.../BTS/BTC/BFC 850-... or devices for switching and control functions via bus audio decoupler BAA 650-...

For more information, see page 64

- **Switching and control functions** are possible with the bus switching modules BSM/BSE/BEM 650-..., feedback to the deluxe bus indoor devices can be programmed.

For more information, see page 123

- **Bus secondary signal unit** BNS 750-... possible.

For more information, see page 132

- **Parallel door and storey call**

Up to 8 bus indoor devices with colour display can be called simultaneously via one call button. From the second bus telephone VIB 150-.../BTSV/BTCV 850-... each device must be additionally supplied at terminals +M/-M.

Only possible within a line.

Every bus video panel must have its own separate supply.

- **Selective dialling of the door station** possible via additional free buttons.

### Remarks

- a)** The TR 603-... (12 V AC, 1.3 A) can supply the door release, camera heating and max. 30 bus call button modules.

Where more bus call button modules are used, an additional TR 603-... is required for the door release.

- b)** Door release/light contact load in the bus video line rectifier BVNG 650-... max. 15 V AC, 30 V DC, 2 A.

- c)** Door release 12 V AC, use at least 20 Ohm (e.g. TÖ 615-...).

For more information, see page 126

- d)** Conductor length bus indoor device – storey call button ERT max. 50 m.

- g)** Power supply via NG 706-30/33-... or via PoE in accordance with IEEE802.3af.

- h)** Each Smart Gateway must be supplied via a separate NG 706-30/33-.... Alternatively, power can also be supplied via PoE according to IEEE 802.3af.

# 6.1 Installation video

Siedle Vario

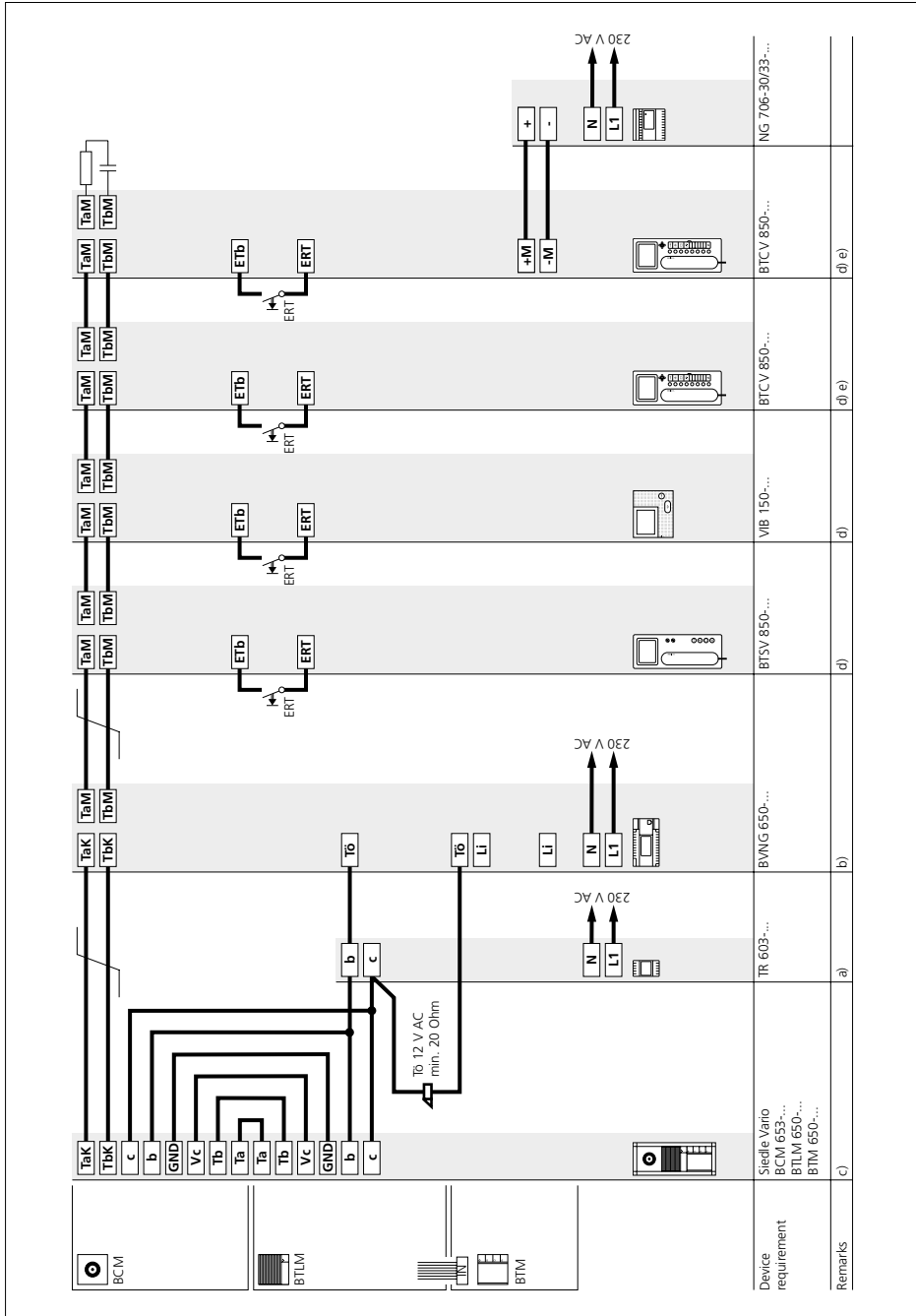

## Siedle Vario

### Functional

Calling, speech and video functions between door station and the connected bus indoor devices with colour display.

Audio and video privacy of existing calls from other bus indoor devices is assured. Door release button for the door release function, light button for the light switching function.

Pressing the monitor button will show the camera picture from the door station which placed the last door call. This function is only possible if no call exists.

Connection of a storey call button (ERT) for calling from an apartment door. Ringtones can be selected for calls from the front door, apartment door or internal calls.

Connection of other bus indoor devices with colour display when looping through from one device to the next.

Other bus door loudspeakers with video are connected with bus video distributors BVVU 650-... or BVVS 650-...

### Supplementary functions

• **Internal speech communication** between bus indoor devices is only possible internally within the same line.

• **Connection of bus telephones** AIB 150-.../BTS/BTC/BFC 850-... or devices for switching and control functions via bus audio decoupler BAA 650-...

For more information, see page 64

• **Switching and control functions** are possible with the bus switching modules BSM/BSE/BEM 650-..., feedback to the deluxe bus indoor devices can be programmed.

For more information, see page 123

• **Bus secondary signal unit** BNS 750-... possible.

For more information, see page 132

• **Parallel door and storey call** Up to 8 bus indoor devices with colour display can be called simultaneously via one call button. From the second bus telephone VIB 150-.../BTSV/BTCV 850-... each device must be additionally supplied at terminals +M/-M.

Only possible within a line.

• **Selective dialling of the door station** possible via additional free buttons.

• **Video memory function** possible with bus indoor devices BTCV/BVPC 850-..., additional installation required.

### Remarks

**a)** The TR 603-... (12 V AC, 1.3 A) can supply the door release, camera heating and max. 30 bus call button modules.

Where more bus call button modules are used, an additional TR 603-... is required for the door release.

**b)** Door release/light contact load in the bus video line rectifier BVNG 650-... max. 15 V AC, 30 V DC, 2 A.

**c)** Door release 12 V AC, use at least 20 Ohm (e.g. TÖ 615-...).

For more information, see page 126

**d)** Conductor length bus indoor device – storey call button ERT max. 50 m.

**e)** When using the video memory module, the bus telephone BTCV 850-... must be supplied by an additional direct voltage (20–30 V DC, 350 mA).

For more information, see page 128

**f)** If several BVVU 650-... units are switched in series, the combination of resistor and capacitor at TaD, TbD must be removed.

## 6.1 Installation video

Siedle Vario with BVVU 650-...

Side circuit

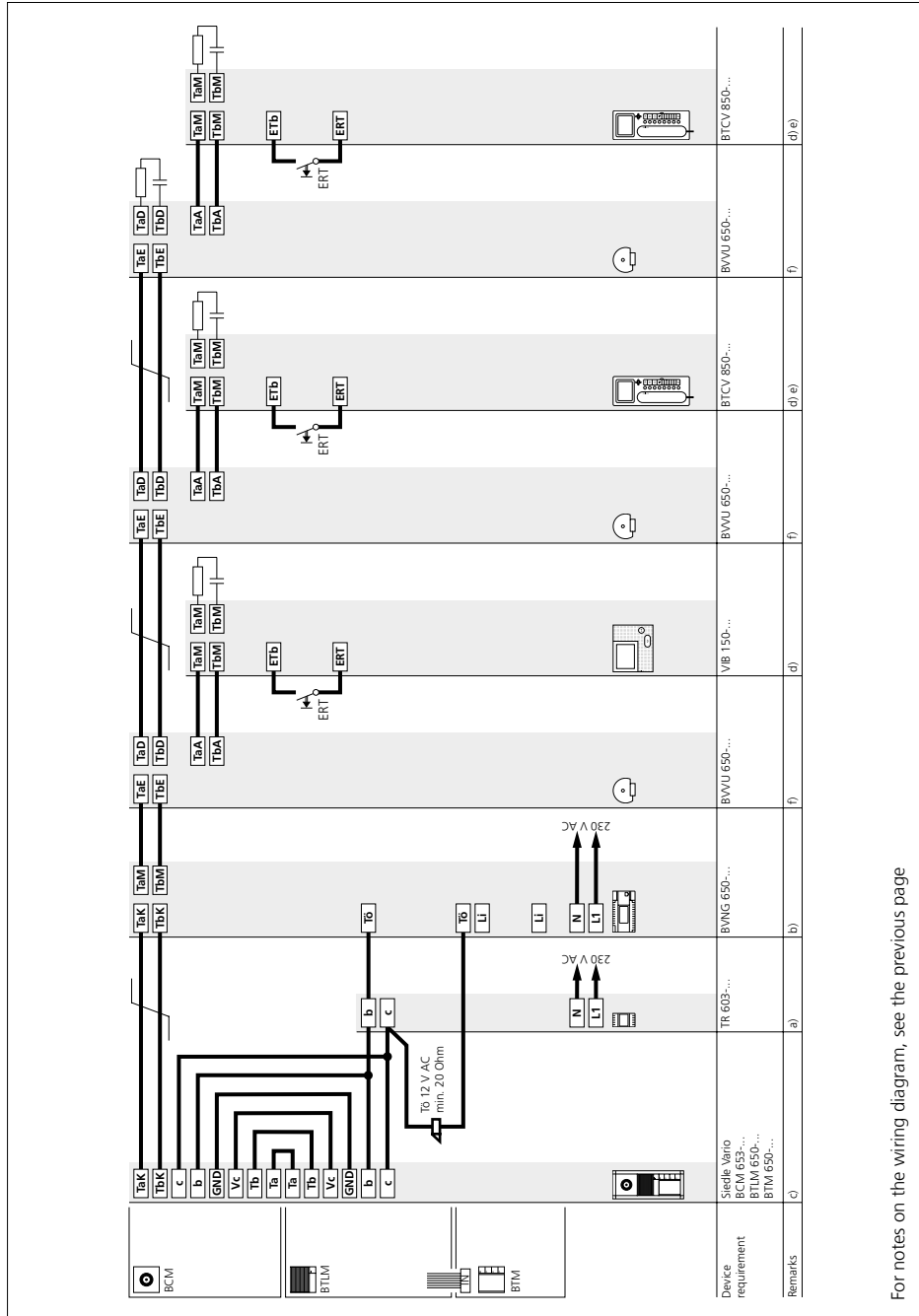

For notes on the wiring diagram, see the previous page.

Siedle Vario with BVU 650-...  
Star-shaped installation

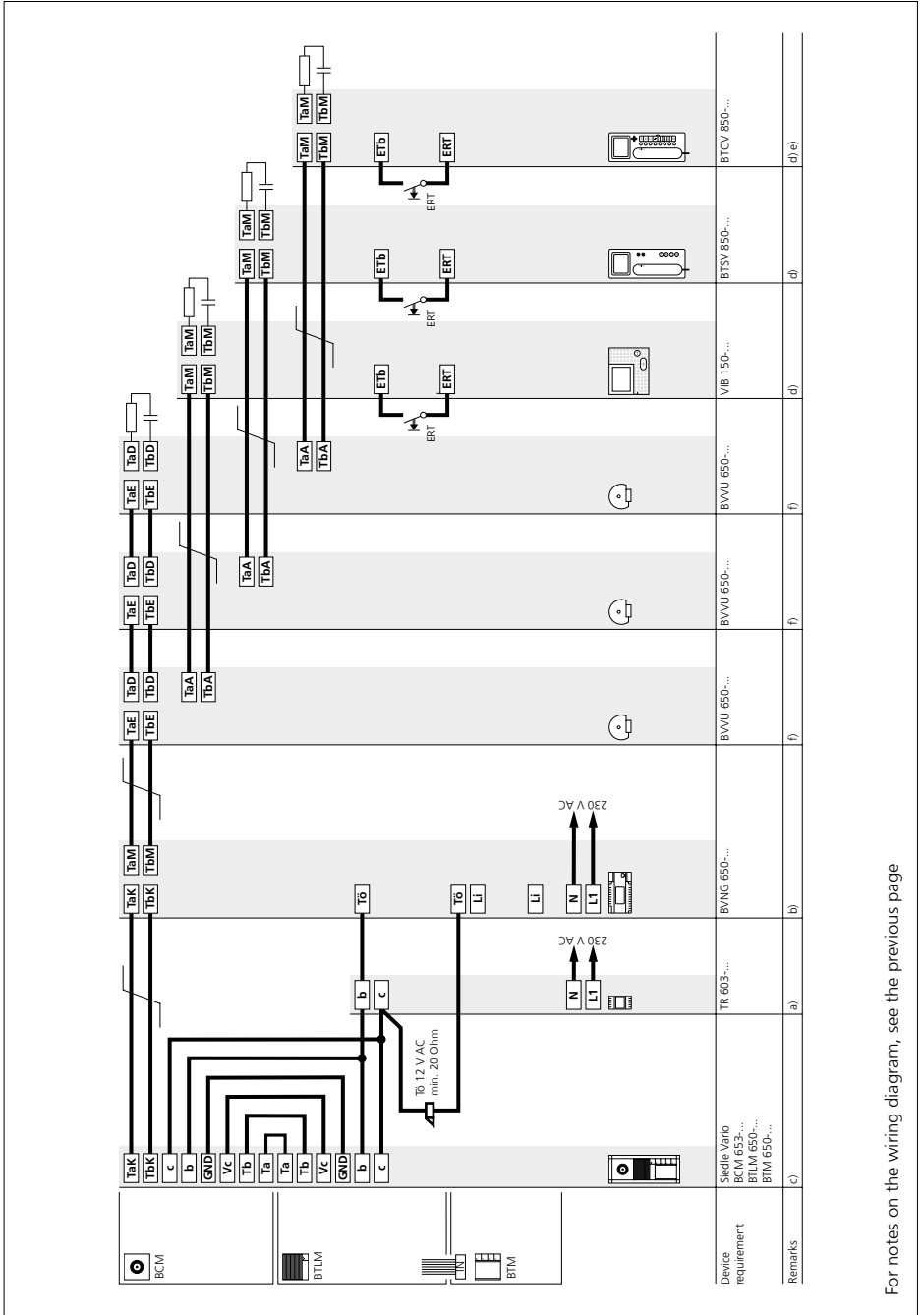

For notes on the wiring diagram, see the previous page

## 6.1 Installation video

Siedle Compact

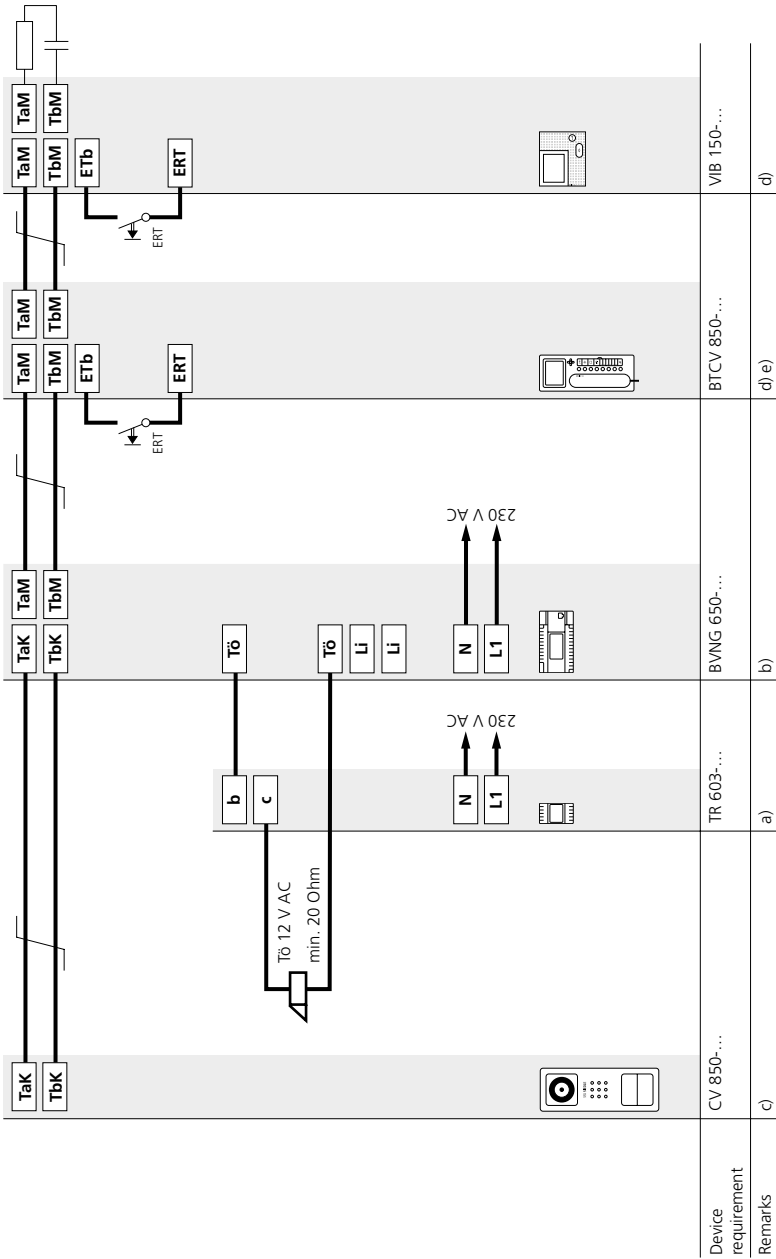



## Siedle Compact

### Functional

Calling, speech and video functions between door station and the connected bus indoor devices with colour display.

Audio and video privacy of existing calls from other bus indoor devices is assured. Door release button for the door release function, light button for the light switching function.

Pressing the monitor button will show the camera picture from the door station which placed the last door call. This function is only possible if no call exists.

Connection of a storey call button (ERT) for calling from an apartment door. Ringtones can be selected for calls from the front door, apartment door or internal calls.

Connection of other bus indoor devices with colour display when looping through from one device to the next.

Other bus door loudspeakers with video are connected with bus video distributors BVVU 650-... or BVVS 650-...

### Supplementary functions

• **Internal speech communication** between bus indoor devices is only possible internally within the same line.

• **Connection of bus telephones** AIB 150-.../BTS/BTC/BFC 850-... or devices for switching and control functions via bus audio decoupler BAA 650-...

For more information, see page 64

• **Switching and control functions** are possible with the bus switching modules BSM/BSE/BEM 650-..., feedback to the deluxe bus indoor devices can be programmed.

For more information, see page 123

• **Bus secondary signal unit** BNS 750-... possible.

For more information, see page 132

• **Parallel door and storey call**

Up to 8 bus indoor devices with colour display can be called simultaneously via one call button. From the second bus telephone VIB 150-.../BTSV/BTCV 850-... each device must be additionally supplied at terminals +M/-M.

Only possible within a line.

• **Selective dialling of the door station** possible via additional free buttons.

• **Video memory function** possible with bus indoor devices BTCV/ BVPC 850-..., additional installation required.

### Remarks

**a)** The TR 603-... (12 V AC, 1.3 A) supplies the door release.

**b)** Door release/light contact load in the bus video line rectifier BVNG 650-... max. 15 V AC, 30 V DC, 2 A.

**c)** Door release 12 V AC, use at least 20 Ohm (e.g. TÖ 615-...). For more information, see page 126

**d)** Conductor length bus indoor device – storey call button ERT max. 50 m.

**e)** When using the video memory module, the bus telephone BTCV 850-... must be supplied by an additional direct voltage (20–30 V DC, 350 mA).

For more information, see page 128

## 6.1 Installation video

### Siedle custom-fit door loudspeaker

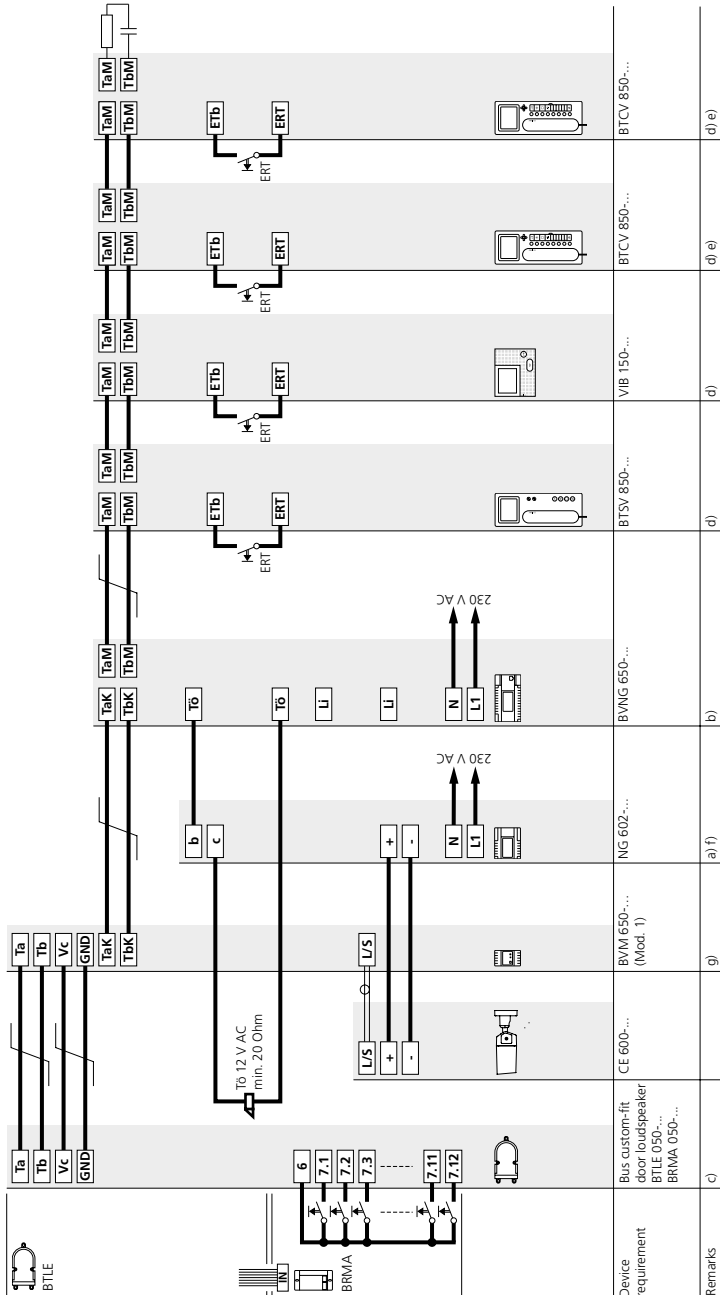

## Siedle custom-fit door loud-speaker

### Functional

Calling, speech and video functions between door station and the connected bus indoor devices with colour display.

Audio and video privacy of existing calls from other bus indoor devices is assured. Door release button for the door release function, light button for the light switching function.

Pressing the monitor button will show the camera picture from the door station which placed the last door call. This function is only possible if no call exists.

Connection of a storey call button (ERT) for calling from an apartment door. Ringtones can be selected for calls from the front door, apartment door or internal calls.

Connection of other bus indoor devices with colour display when looping through from one device to the next.

Other bus door loudspeakers with video are connected with bus video distributors BVVU 650-... or BVVS 650-...

### Supplementary functions

- **Internal speech communication** between bus indoor devices is only possible internally within the same line.

- **Connection of bus telephones** AIB 150-.../BTS/BTC/BFC 850-... or devices for switching and control functions via bus audio decoupler BAA 650-...

For more information, see page 64

- **Switching and control functions** are possible with the bus switching modules BSM/BSE/BEM 650-..., feedback to the deluxe bus indoor devices can be programmed.

For more information, see page 123

- **Bus secondary signal unit** BNS 750-... possible.

For more information, see page 132

- **Parallel door and storey call**

Up to 8 bus indoor devices with colour display can be called simultaneously via one call button. From the second bus telephone VIB 150-.../BTSV/BTCV 850-... each device must be additionally supplied at terminals +M/-M.

Only possible within a line.

- **Selective dialling of the door station** possible via additional free buttons.

- **Video memory function** possible with bus indoor devices BTCV/BVPC 850-..., additional installation required.

### Remarks

**a)** The NG 602-... (12 V AC, 1.6 A) can also provide a supply for illumination of existing call buttons. A voltage of 12 V AC, max. 1 A is available for illumination. With a higher current consumption, an additional transformer must be used.

**b)** Door release/light contact load in the bus video line rectifier BVNG 650-... max. 15 V AC, 30 V DC, 2 A.

**c)** Door release 12 V AC, use at least 20 Ohm (e.g. TÖ 615-...).

For more information, see page 126

**d)** Conductor length bus indoor device – storey call button ERT max. 50 m.

**e)** When using the video memory module, the bus telephone BTCV 850-... must be supplied by an additional direct voltage (20–30 V DC, 350 mA).

For more information, see page 128

**f)** When using camera CE 950-..., a NG 706-30/33-... is required at this point. The door release must then be supplied via an additional TR 603-... .

**g)** The operating mode may only be changed in a de-energised state.

# 6.1 Installation video

## Siedle Classic

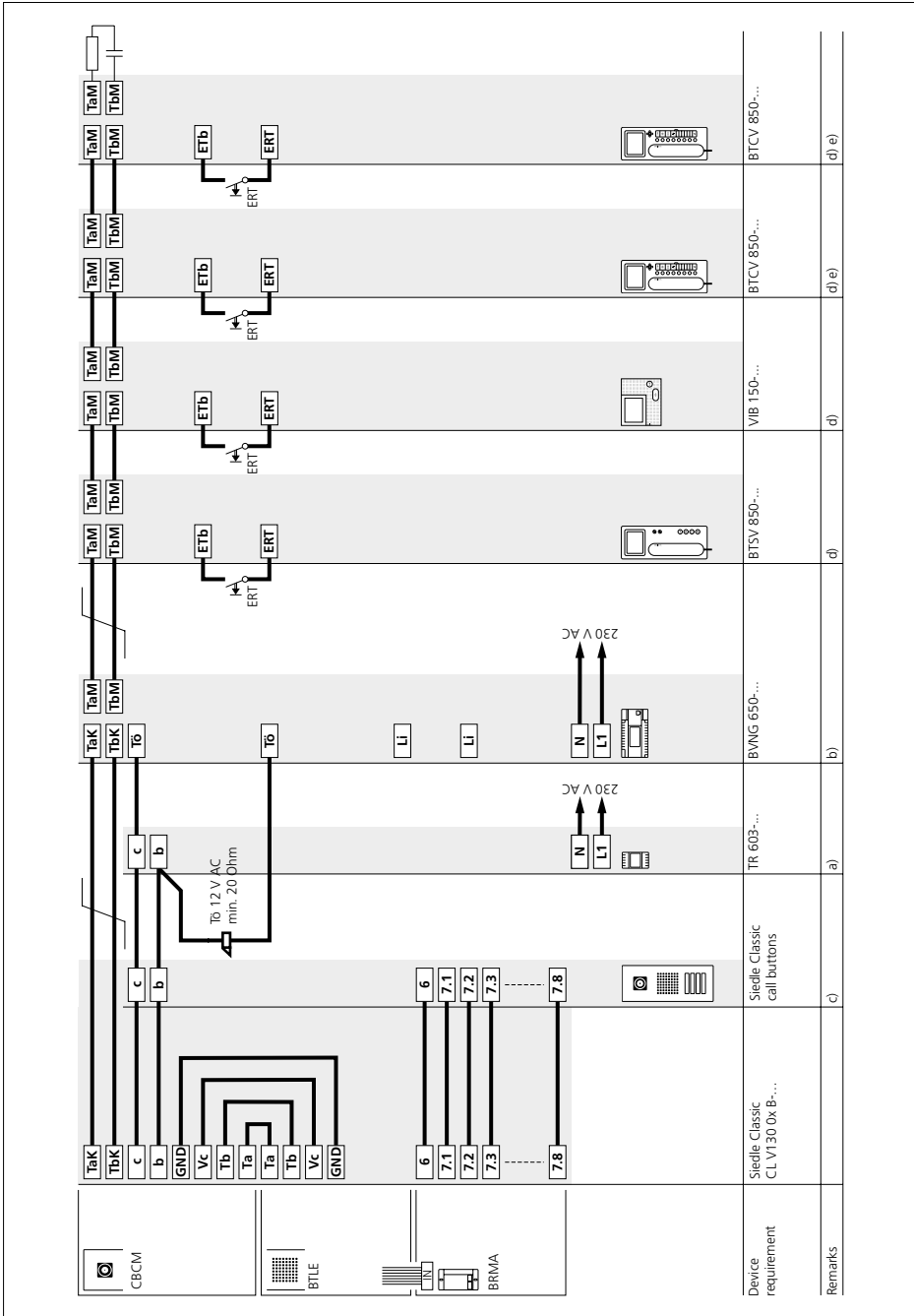

## Siedle Classic

### Functional

Calling, speech and video functions between door station and the connected bus indoor devices with colour display.

Audio and video privacy of existing calls from other bus indoor devices is assured. Door release button for the door release function, light button for the light switching function.

Pressing the monitor button will show the camera picture from the door station which placed the last door call. This function is only possible if no call exists.

Connection of a storey call button (ERT) for calling from an apartment door. Ringtones can be selected for calls from the front door, apartment door or internal calls.

Connection of other bus indoor devices with colour display when looping through from one device to the next.

Other bus door loudspeakers with video are connected with bus video distributors BVVU 650-... or BVVS 650-...

### Supplementary functions

- **Internal speech communication** between bus indoor devices is only possible internally within the same line.

- **Connection of bus telephones** AIB 150-.../BTS/BTC/BFC 850-... or devices for switching and control functions via bus audio decoupler BAA 650-...

For more information, see page 64

- **Switching and control functions** are possible with the bus switching modules BSM/BSE/BEM 650-..., feedback to the deluxe bus indoor devices can be programmed.

For more information, see page 123

- **Bus secondary signal unit** BNS 750-... possible.

For more information, see page 132

- **Parallel door and storey call**

Up to 8 bus indoor devices with colour display can be called simultaneously via one call button. From the second bus telephone VIB 150-.../BTSV/BTCV 850-... each device must be additionally supplied at terminals +M/-M.

Only possible within a line.

- **Selective dialling of the door station** possible via additional free buttons.

- **Video memory function** possible with bus indoor devices BTCV/BVPC 850-..., additional installation required.

### Remarks

- a)** The TR 603-... (12 V AC, 1.3 A) can supply the door release, camera heating and max. 120 bus call buttons.

Where more call buttons are used, an additional TR 603-... is required for the door release.

- b)** Door release/light contact load in the bus video line rectifier BVNG 650-... max. 15 V AC, 30 V DC, 2 A.

- c)** Door release 12 V AC, use at least 20 Ohm (e.g. TÖ 615-...).

For more information, see page 126



- d)** Conductor length bus indoor device – storey call button ERT max. 50 m.

- e)** When using the video memory module, the bus telephone BTCV 850-... must be supplied by an additional direct voltage (20–30 V DC, 350 mA).

For more information, see page 128

## 6.1 Installation video

Siedle Steel

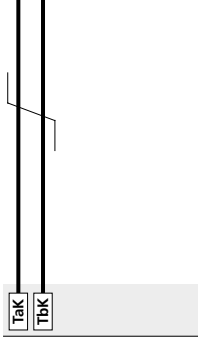
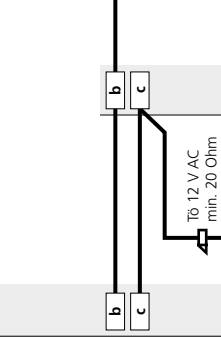
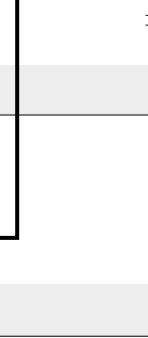
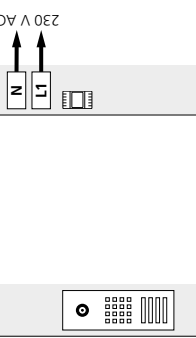
 SBCM	 SBTLM	 Call buttons					TR 603-...	b)	B'VING 650-...	d)	BTSV 850-...	d)	VIB 150-...	d)	BTCV 850-...	d) e)	BTCV 850-...	d) e)
Device requirement		Remarks																

## Siedle Steel

### Functional

Calling, speech and video functions between door station and the connected bus indoor devices with colour display.

Audio and video privacy of existing calls from other bus indoor devices is assured. Door release button for the door release function, light button for the light switching function.

Pressing the monitor button will show the camera picture from the door station which placed the last door call. This function is only possible if no call exists.

Connection of a storey call button (ERT) for calling from an apartment door. Ringtones can be selected for calls from the front door, apartment door or internal calls.

Connection of other bus indoor devices with colour display when looping through from one device to the next.

Other bus door loudspeakers with video are connected with bus video distributors BVVU 650-... or BVVS 650-...

### Supplementary functions

• **Internal speech communication** between bus indoor devices is only possible internally within the same line.

• **Connection of bus telephones** AIB 150-.../BTS/BTC/BFC 850-... or devices for switching and control functions via bus audio decoupler BAA 650-...

For more information, see page 64

• **Switching and control functions** are possible with the bus switching modules BSM/BSE/BEM 650-..., feedback to the deluxe bus indoor devices can be programmed.

For more information, see page 123

• **Bus secondary signal unit** BNS 750-... possible.

For more information, see page 132

• **Parallel door and storey call** Up to 8 bus indoor devices with colour display can be called simultaneously via one call button. From the second bus telephone VIB 150-.../BTSV/BTCV 850-... each device must be additionally supplied at terminals +M/-M.

Only possible within a line.

• **Selective dialling of the door station** possible via additional free buttons.

• **Video memory function** possible with bus indoor devices BTCV/BVPC 850-..., additional installation required.

### Remarks

**a)** The TR 603-... (12 V AC, 1.3 A) can supply the door release, camera heating and max. 200 bus call buttons.

Where more call buttons are used, an additional TR 603-... is required for the door release.

**b)** Door release/light contact load in the bus video line rectifier BVNG 650-... max. 15 V AC, 30 V DC, 2 A.

**c)** Door release 12 V AC, use at least 20 Ohm (e.g. TÖ 615-...).

For more information, see page 126

**d)** Conductor length bus indoor device – storey call button ERT max. 50 m.

**e)** When using the video memory module, the bus telephone BTCV 850-... must be supplied by an additional direct voltage (20–30 V DC, 350 mA).

For more information, see page 128

## 6.1 Installation video

### Siedle Vario 2 door stations

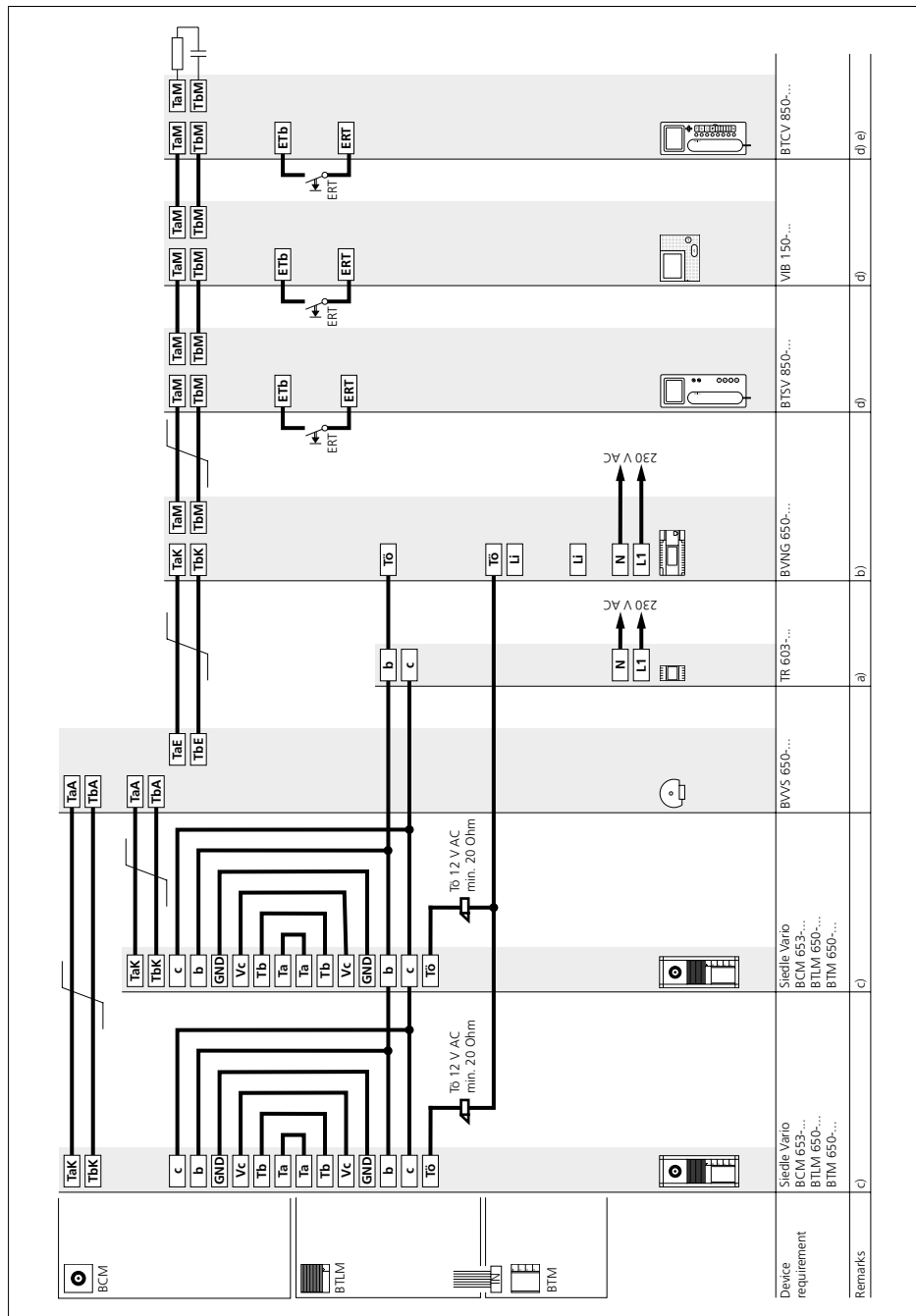



## Siedle Vario 2 door stations

### Functional

Calling, speech and video functions between door station and the connected bus indoor devices with colour display.

Audio and video privacy of existing calls from other bus indoor devices is assured. Door release button for the door release function, light button for the light switching function.

Pressing the monitor button will show the camera picture from the door station which placed the last door call. This function is only possible if no call exists.

Connection of a storey call button (ERT) for calling from an apartment door. Ringtones can be selected for calls from the front door, apartment door or internal calls.

Connection of other bus indoor devices with colour display when looping through from one device to the next.

Other bus door loudspeakers with video are connected with bus video distributors BVVU 650-... or BVVS 650-...

### Supplementary functions

• **Internal speech communication** between bus indoor devices is only possible internally within the same line.

• **Connection of bus telephones** AIB 150-.../BTS/BTC/BFC 850-... or devices for switching and control functions via bus audio decoupler BAA 650-...

For more information, see page 64

• **Switching and control functions** are possible with the bus switching modules BSM/BSE/BEM 650-..., feedback to the deluxe bus indoor devices can be programmed.

For more information, see page 123

• **Bus secondary signal unit** BNS 750-... possible.

For more information, see page 132

• **Parallel door and storey call** Up to 8 bus indoor devices with colour display can be called simultaneously via one call button. From the second bus telephone VIB 150-.../BTSV/BTCV 850-... each device must be additionally supplied at terminals +M/-M.

Only possible within a line.

• **Selective dialling of the door station** possible via additional free buttons.

• **Video memory function** possible with bus indoor devices BTCV/BVPC 850-..., additional installation required.

### Remarks

**a)** The TR 603-... (12 V AC, 1.3 A) can supply the door release, camera heating and max. 25 bus call button modules.

Where more bus call button modules are used, an additional TR 603-... is required for the door release.

**b)** Door release/light contact load in the bus video line rectifier BVNG 650-... max. 15 V AC, 30 V DC, 2 A.

**c)** Door release 12 V AC, use at least 20 Ohm (e.g. TÖ 615-...).

For more information, see page 126

**d)** Conductor length bus indoor device – storey call button ERT max. 50 m.

**e)** When using the video memory module, the bus telephone BTCV 850-... must be supplied by an additional direct voltage (20–30 V DC, 350 mA).

For more information, see page 128

## 6.1 Installation video

### Multiple line system

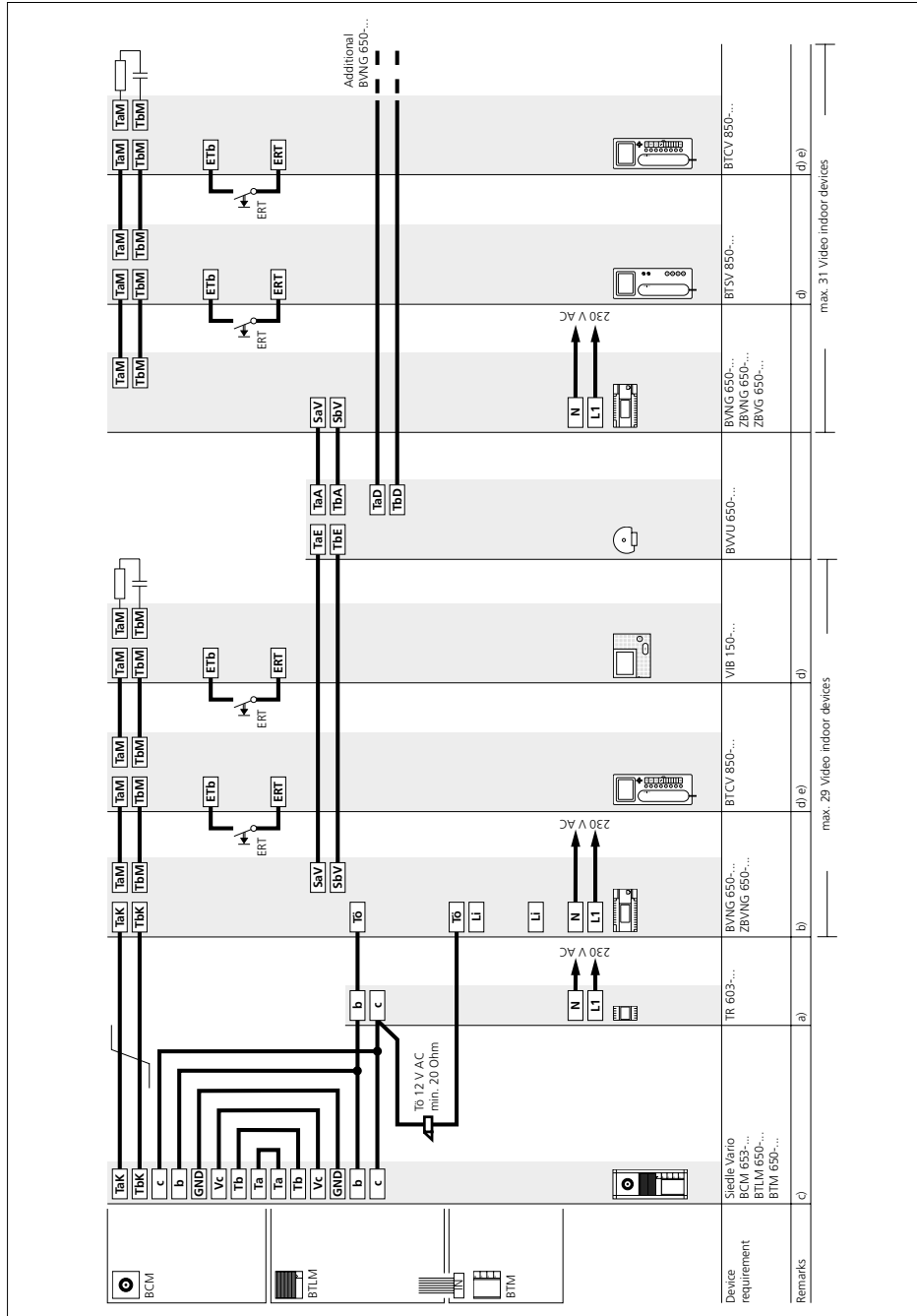

## Multiple line system

### Functional

Calling, speech and video functions between door station and the connected bus indoor devices with colour display.

Audio and video privacy of existing calls from other bus indoor devices is assured. Door release button for the door release function, light button for the light switching function.

Pressing the monitor button will show the camera picture from the door station which placed the last door call. This function is only possible if no call exists.

Connection of a storey call button (ERT) for calling from an apartment door. Ringtones can be selected for calls from the front door, apartment door or internal calls.

Connection of other bus indoor devices with colour display when looping through from one device to the next.

Other bus door loudspeakers with video are connected with bus video distributors BVVU 650-... or BVVS 650-...

In a multiple line system comprising only 2 lines, connection between the two bus video line rectifiers is possible without bus distributor BVVU 650-... Up to 15 lines can be linked via BVVU 650-...

### Supplementary functions

- **Internal speech communication** between bus indoor devices is only possible internally within the same line.

- **Connection of bus telephones** AIB 150-.../BTS/BTC/BFC 850-... or devices for switching and control functions via bus audio decoupler BAA 650-...

For more information, see page 64

- **Switching and control functions** are possible with the bus switching modules BSM/BSE/BEM 650-..., feedback to the deluxe bus indoor devices can be programmed.

For more information, see page 123

- **Bus secondary signal unit** BNS 750-... possible.

For more information, see page 132

- **Parallel door and storey call** Up to 8 bus indoor devices with colour display can be called simultaneously via one call button. From the second bus telephone VIB 150-.../BTSV/BTCV 850-... each device must be additionally supplied at terminals +M/-M.

Only possible within a line.

- **Selective dialling of the door station** possible via additional free buttons.

- **Video memory function** possible with bus indoor devices BTCV/BVPC 850-..., additional installation required.

### Remarks

- a)** The TR 603-... (12 V AC, 1.3 A) can supply the door release, camera heating and max. 30 bus call button modules.

Where more bus call button modules are used, an additional TR 603-... is required for the door release.

- b)** Door release/light contact load in the bus video line rectifier BVNG 650-... max. 15 V AC, 30 V DC, 2 A.

- c)** Door release 12 V AC, use at least 20 Ohm (e.g. TÖ 615-...).

For more information, see page 126

- d)** Conductor length bus indoor device – storey call button ERT max. 50 m.

- e)** When using the video memory module, the bus telephone BTCV 850-... must be supplied by an additional direct voltage (20–30 V DC, 350 mA).

For more information, see page 128

## 6.1 Installation video

Call via display call module

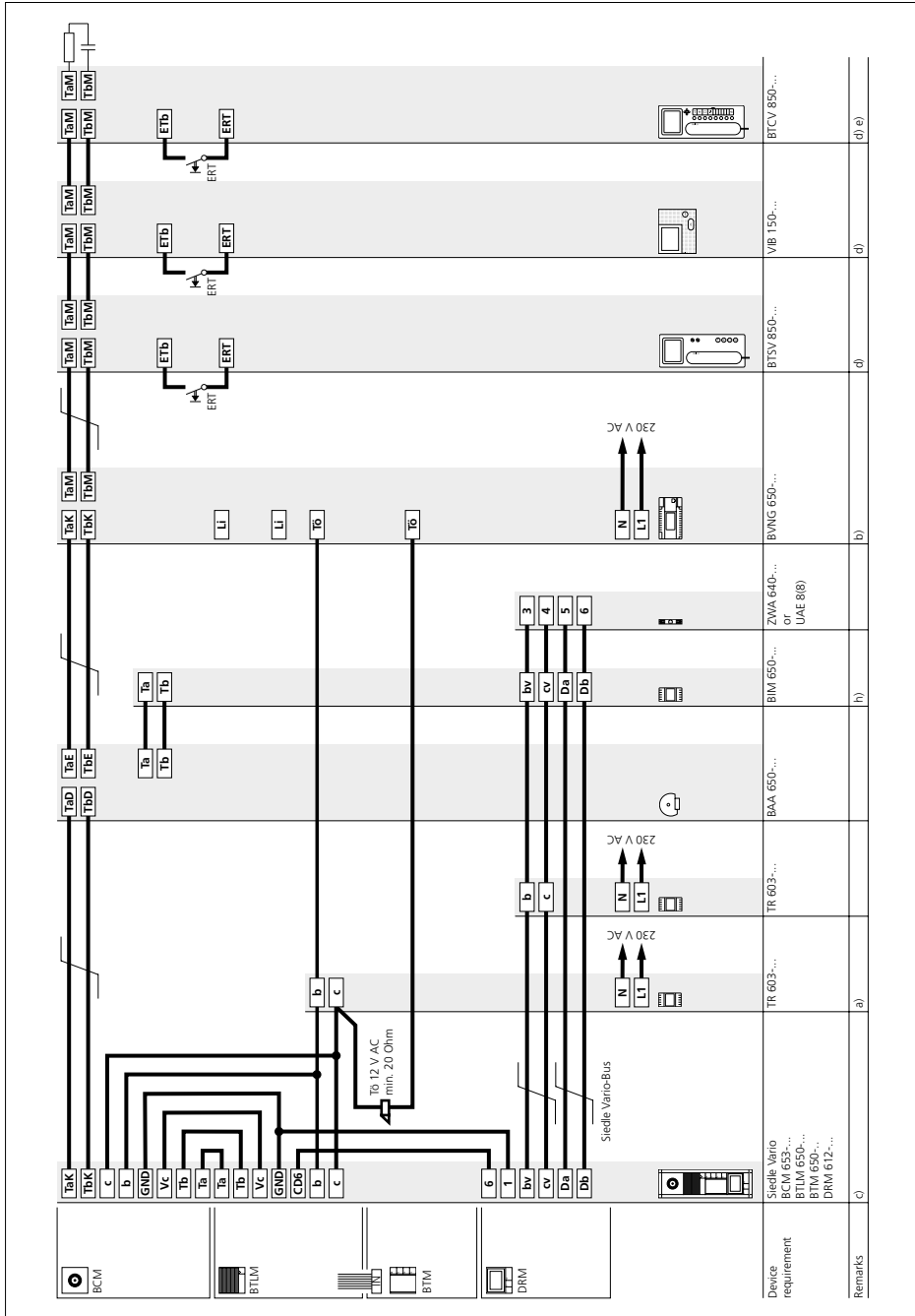

## Call via display call module

### Functional

Calling, speech and video functions between door station and the connected bus indoor devices with colour display.

Selection of bus indoor devices via the display call module. Selection of names takes place in alphabetical order. Connection of bus call button modules possible, e.g. for door call at the reception.

Audio and video privacy of existing calls from other bus indoor devices is assured. Door release button for the door station which placed the last door call for the light switching function. Pressing the monitor button will show the camera picture from the door station which placed the last door call. This function is only possible if no call exists.

Connection of a storey call button (ERT) for calling from an apartment door. Ringtones can be selected for calls from the front door, apartment door or internal calls.

Connection of other bus indoor devices with colour display when looping through from one device to the next.

Other bus door loudspeakers with video are connected with bus video distributors BVVU 650-... or BVVS 650-...

### Supplementary functions

• **Internal speech communication** between bus indoor devices is only possible internally within the same line.

• **Connection of bus telephones** AIB 150-.../BTS/BTC/BFC 850-... or devices for switching and control functions via bus audio decoupler BAA 650-...

For more information, see page 64

• **Switching and control functions** are possible with the bus switching modules BSM/BSE/BEM 650-..., feedback to the deluxe bus indoor devices can be programmed.

For more information, see page 123

• **Bus secondary signal unit** BNS 750-... possible.

For more information, see page 132

• **Parallel door and storey call**

Up to 8 bus indoor devices with colour display can be called simultaneously via one call button. From the second bus telephone VIB 150-.../BTSV/BTCV 850-... each device must be additionally supplied at terminals +M/-M.

Only possible within a line.

• **Selective dialling of the door station** possible via additional free buttons.

• **Video memory function** possible with bus indoor devices BTCV/BVPC 850-..., additional installation required.

### Remarks

**a)** The TR 603-... (12 V AC, 1.3 A) can supply the door release, camera heating and max. 30 bus call button modules.

Where more bus call button modules are used, an additional TR 603-... is required for the door release.

**b)** Door release/light contact load in the bus video line rectifier BVNG 650-... max. 15 V AC, 30 V DC, 2 A.

**c)** Door release 12 V AC, use at least 20 Ohm (e.g. TÖ 615-...). For more information, see page 126

**d)** Conductor length bus indoor device – storey call button ERT max. 50 m.

**e)** When using the video memory module, the bus telephone BTCV 850-... must be supplied by an additional direct voltage (20–30 V DC, 350 mA).

For more information, see page 128

**h)** For programming names, the programming software PRS 602-0 and programming interface PRI 602-0/BIM 650-... are required. Names are entered in the display call module using the PRS 602-0 from V 1.3.1. Connection with e.g. ZWA 640-...



## Additional external camera

### Functional

Calling, speech and video functions between door station and the connected bus indoor devices with colour display.

Audio and video privacy of existing calls from other bus indoor devices is assured. Door release button for the door release function, light button for the light switching function.

Pressing the monitor button will show the camera picture from the door station which placed the last door call. This function is only possible if no call exists.

Connection of a storey call button (ERT) for calling from an apartment door. Ringtones can be selected for calls from the front door, apartment door or internal calls.

Connection of other bus indoor devices with colour display when looping through from one device to the next.

Other bus door loudspeakers with video are connected with bus video distributors BVVU 650-... or BVVS 650-...

## Supplementary functions

- **Internal speech communication** between bus indoor devices is only possible internally within the same line.

- **Connection of bus telephones** AIB 150-.../BTS/BTC/BFC 850-... or devices for switching and control functions via bus audio decoupler BAA 650-...

For more information, see page 64

- **Switching and control functions** are possible with the bus switching modules BSM/BSE/BEM 650-..., feedback to the deluxe bus indoor devices can be programmed.

For more information, see page 123

- **Bus secondary signal unit** BNS 750-... possible.

For more information, see page 132

- **Parallel door and storey call** Up to 8 bus indoor devices with colour display can be called simultaneously via one call button. From the second bus telephone VIB 150-.../BTSV/BTCV 850-... each device must be additionally supplied at terminals +M/-M.

Only possible within a line.

- **Selective dialling of the door station** possible via additional free buttons.

- **Video memory function** possible with bus indoor devices BTCV/BVPC 850-..., additional installation required.

## Remarks

- a)** The NG 602-... (12 V AC, 1.6 A) can supply the door release, camera heating and max. 34 bus call button modules.

Where more bus call button modules are used, an additional TR 603-... is required for the door release.

- b)** Door release/light contact load in the bus video line rectifier BVNG 650-... max. 15 V AC, 30 V DC, 2 A.

- c)** Door release 12 V AC, use at least 20 Ohm (e.g. TÖ 615-...).

For more information, see page 126

- d)** Conductor length bus indoor device – storey call button ERT max. 50 m.

- e)** When using the video memory module, the bus telephone BTCV 850-... must be supplied by an additional direct voltage (20–30 V DC, 350 mA).

For more information, see page 128

- f)** When using camera CE 950-..., a NG 706-30/33-... is required at this point. The door release must then be supplied via an additional TR 603-... .

- g)** The operating mode may only be changed in a de-energised state.

## 6.2 Installation audio & video

Siedle Vario

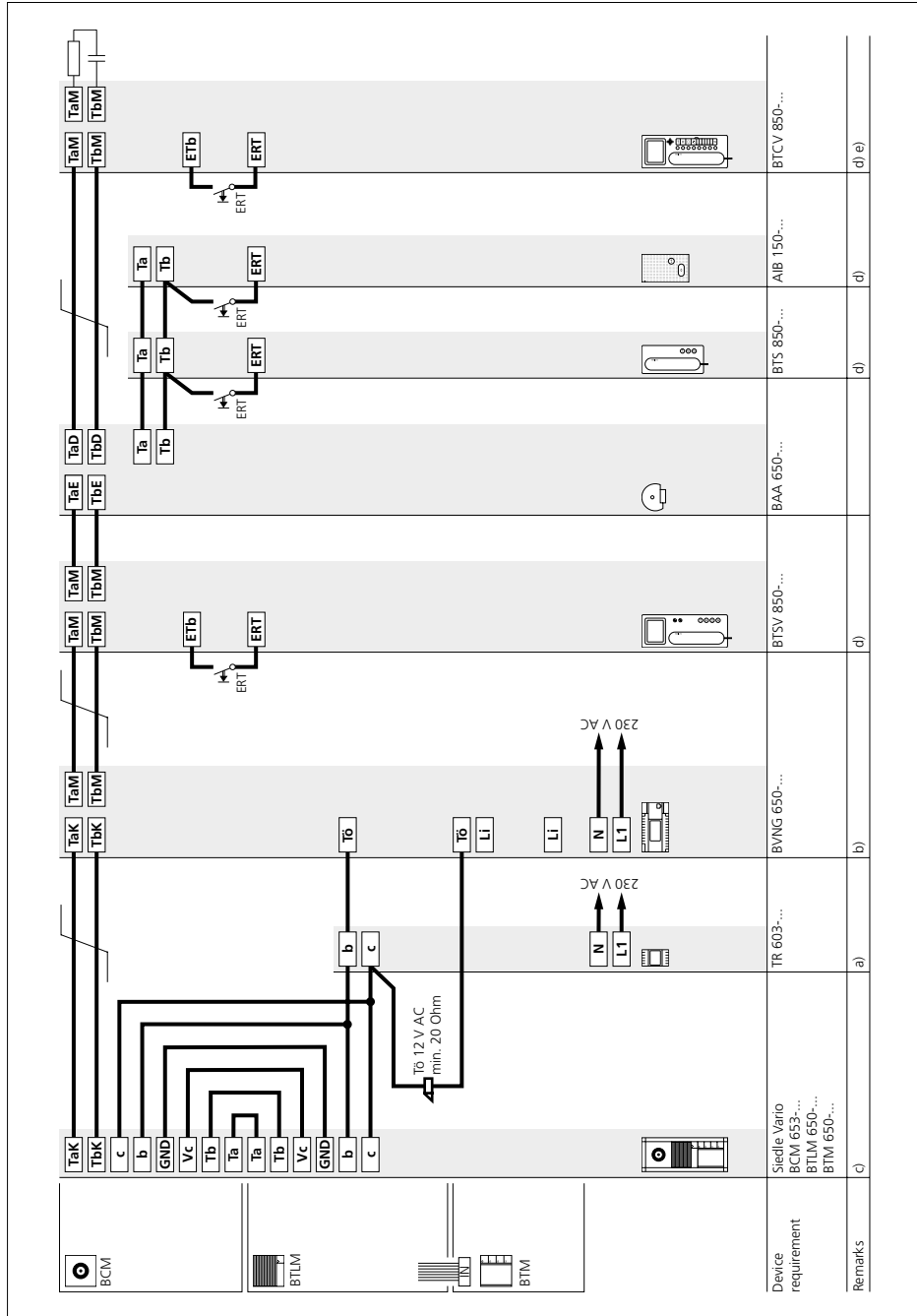



## Siedle Vario

### Functional

Calling, speech and video functions between door station and the connected bus indoor devices with colour display.

Calling and speech between the door station and connected bus telephones AIB 150-.../BTS/BTC/BFC 850-...

Audio and video privacy of existing calls from other bus indoor devices is assured. Door release button for the door release function, light button for the light switching function. Pressing the monitor button will show the camera picture from the door station which placed the last door call. This function is only possible if no call exists.

Connection of a storey call button (ERT) for calling from an apartment door. Ringtones can be selected for calls from the front door, apartment door or internal calls.

Connection of other bus indoor devices with colour display when looping through from one device to the next.

Other bus door loudspeakers with video are connected with bus video distributors BVVU 650-... or BVVS 650-...

### Supplementary functions

• **Internal speech communication** between bus indoor devices is only possible internally within the same line.

• **Switching and control functions** are possible with the bus switching modules BSM/BSE/BEM 650-..., feedback to the deluxe bus indoor devices can be programmed. For more information, see page 123

• **Bus secondary signal unit** BNS 750-... possible. For more information, see page 132

• **Parallel door and storey call** Up to 8 bus indoor devices with colour display can be called simultaneously via one call button. From the second bus telephone VIB 150-.../BTSV/BTCV 850-... each device must be additionally supplied at terminals +M/-M.

Only possible within a line.

• **Selective dialling of the door station** possible via additional free buttons.

• **Video memory function** possible with bus indoor devices BTCV/BVPC 850-..., additional installation required.

### Remarks

**a)** The TR 603-... (12 V AC, 1.3 A) can supply the door release, camera heating and max. 30 bus call button modules.

Where more bus call button modules are used, an additional TR 603-... is required for the door release.

**b)** Door release/light contact load in the bus video line rectifier BVNG 650-... max. 15 V AC, 30 V DC, 2 A.

**c)** Door release 12 V AC, use at least 20 Ohm (e.g. TÖ 615-...). For more information, see page 126

**d)** Conductor length bus indoor device – storey call button ERT max. 50 m.

**e)** When using the video memory module, the bus telephone BTCV 850-... must be supplied by an additional direct voltage (20–30 V DC, 350 mA). For more information, see page 128

## 6.2 Installation audio & video

### DoorCom Analog DCA 650-...

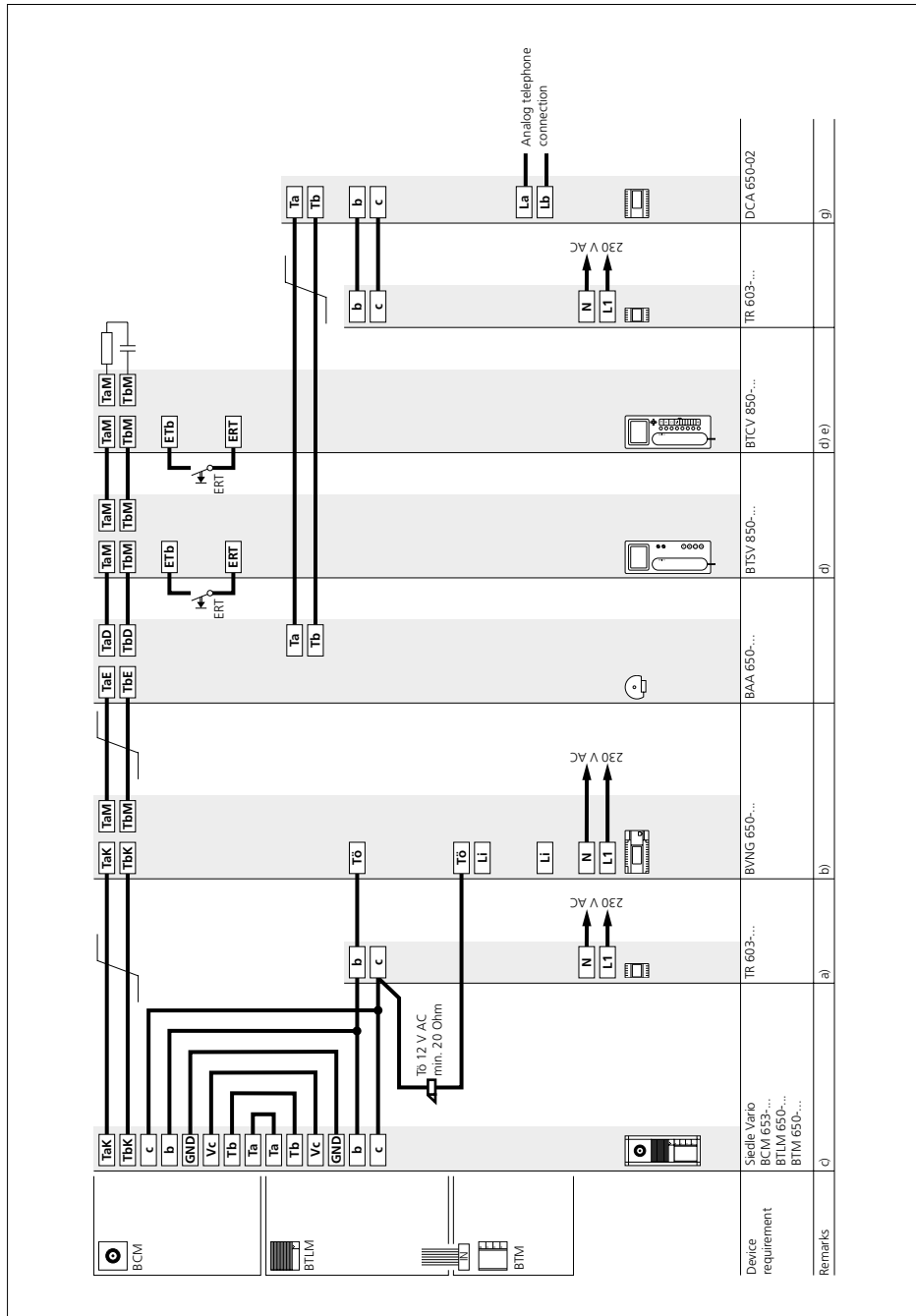

## DoorCom Analog DCA 650-...

### Functional

Calling and speech between the door station and the connected a/b telephones of a telephone system. The DoorCom-Analog DCA 650-02 is able to forward the call from up to 31 bell buttons to a telephone system. The DCA 650-02 calls the PBX extensions of the telephone system using dual-tone multiple frequency dialling DTMF. Audio and video privacy of existing calls from other telephones is assured. The function for door release and light switching via DTMF symbols is possible at connected a/b telephones in the telephone system.

Connection of other bus indoor devices with colour display when looping through from one device to the next.

Other bus door loudspeakers with video are connected with bus video distributors BVVU 650-... or BVVS 650-...

### Supplementary functions

- **Internal speech communication** between bus indoor devices is only possible internally within the same line.

- **Connection of bus telephones** AIB 150-.../BTS/BTC/BFC 850-... or devices for switching and control functions via bus audio decoupler BAA 650-...

For more information, see page 64

- **Switching and control functions** are possible with the bus switching modules BSM/BSE/BEM 650-..., feedback to the deluxe bus indoor devices can be programmed.

For more information, see page 123

- **Bus secondary signal unit** BNS 750-... possible.

For more information, see page 132

- **Parallel door and storey call** Up to 8 bus indoor devices with colour display can be called simultaneously via one call button. From the second bus telephone VIB 150-.../BTSV/BTCV 850-... each device must be additionally supplied at terminals +M/-M.

Only possible within a line.

- **Selective dialling of the door station** possible via additional free buttons.

- **Video memory function** possible with bus indoor devices BTCV/BVPC 850-..., additional installation required.

### Remarks

- a)** The TR 603-... (12 V AC, 1.3 A) can supply the door release, camera heating and max. 30 bus call button modules.

Where more bus call button modules are used, an additional TR 603-... is required for the door release.

- b)** Door release/light contact load in the bus video line rectifier BVNG 650-... max. 15 V AC, 30 V DC, 2 A.

- c)** Door release 12 V AC, use at least 20 Ohm (e.g. TÖ 615-...).

For more information, see page 126

- d)** Conductor length bus indoor device – storey call button ERT max. 50 m.

- e)** When using the video memory module, the bus telephone BTCV 850-... must be supplied by an additional direct voltage (20–30 V DC, 350 mA).

For more information, see page 128

- g)** Every DCA 650-... must be supplied via a separate TR 603-... If the predecessor model DCA 650-0 is used, the operating mode switch of the BNG/BVNG 650-... must be in position 1. The maximum distance of the DCA 650-... from the TR 603-... is 20 m.



## Siedle Vario 3 door stations

### Functional

Calling, speech and video functions between door station and the connected bus indoor devices with colour display.

Call and speech functions from the door station without video.

Audio and video privacy of existing calls from other bus indoor devices is assured. Via BAA 650-... in the monitor branch, it is also possible to connect bus telephones AIB 150-..., BTS/BTC/BFC 850-.... Door release button for the door release function, light button for the light switching function. Pressing the monitor button will show the camera picture from the door station which placed the last door call. This function is only possible if no call exists.

Connection of a storey call button (ERT) for calling from an apartment door. Ringtones can be selected for calls from the front door, apartment door or internal calls.

Connection of other bus indoor devices with colour display when looping through from one device to the next.

Other bus door loudspeakers with video are connected with bus video distributors BVVU 650-... or BVVS 650-...

### Supplementary functions

- **Internal speech communication** between bus indoor devices is only possible internally within the same line.

- **Connection of bus telephones** AIB 150-.../BTS/BTC/BFC 850-... or devices for switching and control functions via bus audio decoupler BAA 650-...

For more information, see page 64

- **Switching and control functions** are possible with the bus switching modules BSM/BSE/BEM 650-..., feedback to the deluxe bus indoor devices can be programmed.

For more information, see page 123

- **Bus secondary signal unit** BNS 750-... possible.

For more information, see page 132

- **Parallel door and storey call** Up to 8 bus indoor devices with colour display can be called simultaneously via one call button. From the second bus telephone VIB 150-.../BTSV/BTCV 850-... each device must be additionally supplied at terminals +M/-M.

Only possible within a line.

- **Selective dialling of the door station** possible via additional free buttons.

- **Video memory function** possible with bus indoor devices BTCV/BVPC 850-..., additional installation required.

### Remarks

- a)** The TR 603-... (12 V AC, 1.3 A) can supply the door release, camera heating and max. 30 bus call button modules.

Where more bus call button modules are used, an additional TR 603-... is required for the door release.

- b)** Door release/light contact load in the bus video line rectifier BVNG 650-... max. 15 V AC, 30 V DC, 2 A.

- c)** Door release 12 V AC, use at least 20 Ohm (e.g. TÖ 615-...).

For more information, see page 126

- d)** Conductor length bus indoor device – storey call button ERT max. 50 m.

- e)** When using the video memory module, the bus telephone BTCV 850-... must be supplied by an additional direct voltage (20–30 V DC, 350 mA).

For more information, see page 128

## 6.2 Installation audio & video

### Multiple line system

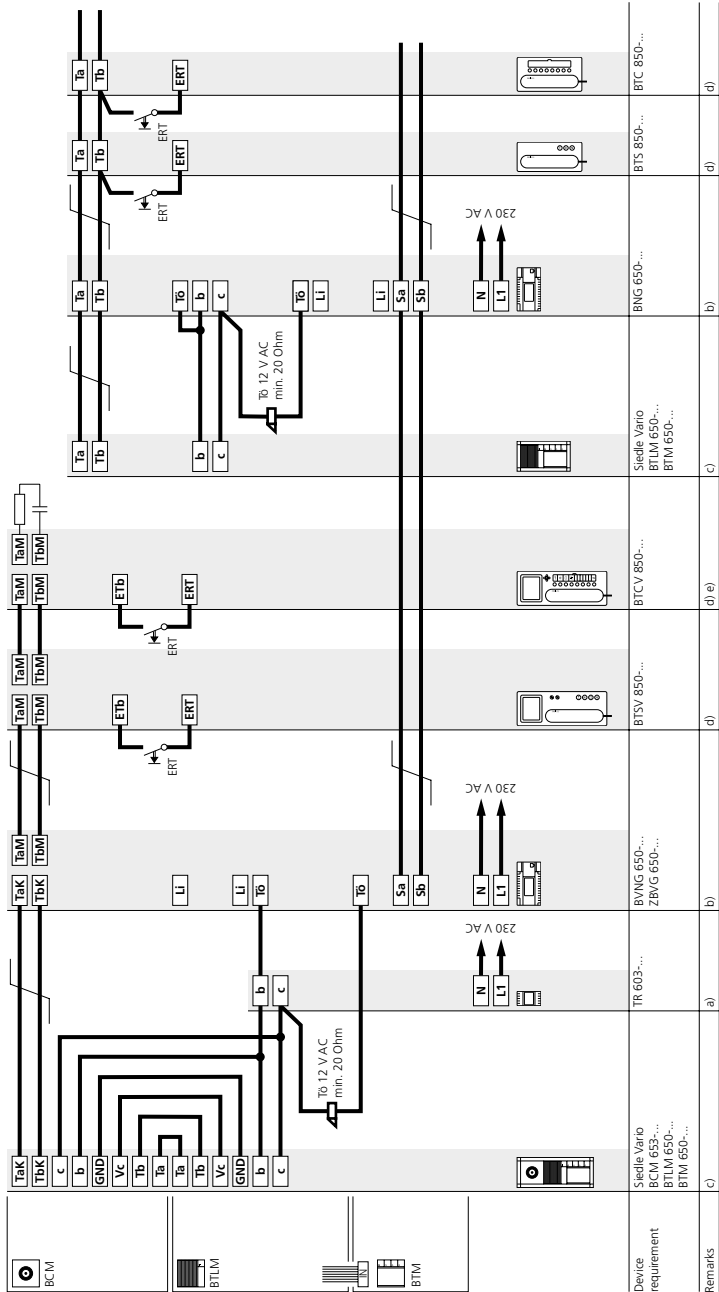

## Multiple line system

### Functional

Calling, speech and video functions between door station and the connected bus indoor devices with colour display.

Calling and speech between the door station and connected bus telephones AIB 150-.../BTS/BTC/BFC 850-...

Audio and video privacy of existing calls from other bus indoor devices is assured. Door release button for the door release function, light button for the light switching function. Pressing the monitor button will show the camera picture from the door station which placed the last door call. This function is only possible if no call exists.

Connection of a storey call button (ERT) for calling from an apartment door. Ringtones can be selected for calls from the front door, apartment door or internal calls.

Connection of other bus indoor devices with colour display when looping through from one device to the next.

Other bus door loudspeakers with video are connected with bus video distributors BVVU 650-... or BVVS 650-...

### Supplementary functions

- **Internal speech communication** between bus indoor devices is only possible internally within the same line.

- **Connection of bus telephones** AIB 150-.../BTS/BTC/BFC 850-... or devices for switching and control functions via bus audio decoupler BAA 650-...

For more information, see page 64

- **Switching and control functions** are possible with the bus switching modules BSM/BSE/BEM 650-..., feedback to the deluxe bus indoor devices can be programmed.

For more information, see page 123

- **Bus secondary signal unit** BNS 750-... possible.

For more information, see page 132

- **Parallel door and storey call**

Up to 8 bus indoor devices with colour display can be called simultaneously via one call button. From the second bus telephone VIB 150-.../BTSV/BTCV 850-... each device must be additionally supplied at terminals +M/-M.

Only possible within a line.

- **Selective dialling of the door station** possible via additional free buttons.

- **Video memory function** possible with bus indoor devices BTCV/BVPC 850-..., additional installation required.

### Remarks

- a)** The TR 603-... (12 V AC, 1.3 A) can supply the door release, camera heating and max. 30 bus call button modules.

Where more bus call button modules are used, an additional TR 603-... is required for the door release.

- b)** Door release/light contact load in the bus video line rectifier BVNG 650-... max. 15 V AC, 30 V DC, 2 A.

- c)** Door release 12 V AC, use at least 20 Ohm (e.g. TÖ 615-...).

For more information, see page 126

- d)** Conductor length bus indoor device – storey call button ERT max. 50 m.

- e)** When using the video memory module, the bus telephone BTCV 850-... must be supplied by an additional direct voltage (20–30 V DC, 350 mA).

For more information, see page 128

### 6.3 Siedle Systemtechnik installation

Jung video indoor station

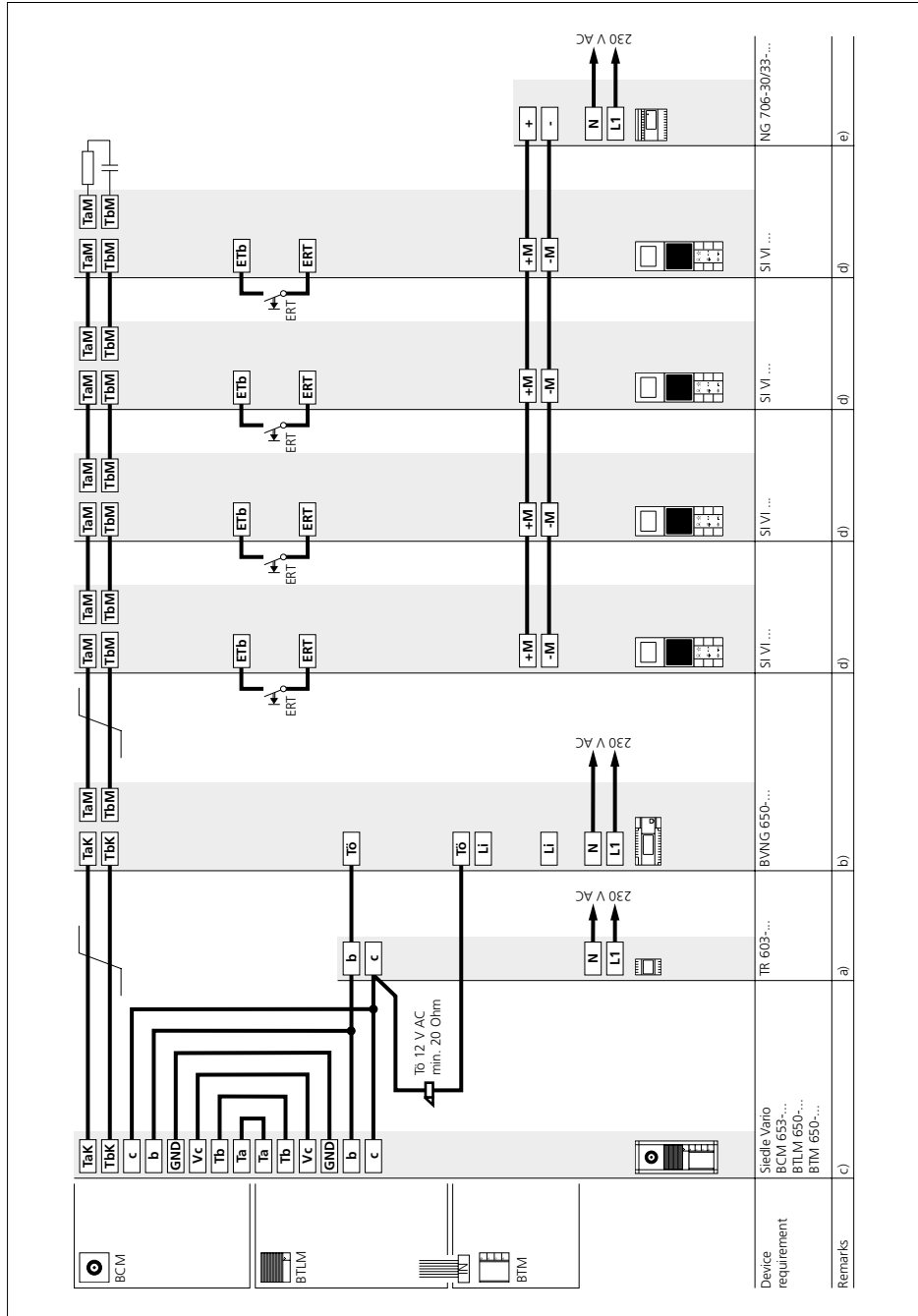



## Jung video indoor station

### Functional

Calling, speech and video functions between door station and the connected Jung video indoor stations.

Audio and video privacy of existing calls from other bus indoor devices is assured. Door release button for the door release function, light button for the light switching function. Pressing the picture connection button will show the camera picture from the door station which placed the last door call. This function is only possible if no call exists.

Connection of a storey call button (ERT) for calling from an apartment door. Ringtones can be selected for calls from the front door, apartment door or internal calls.

Connection of other bus indoor devices with colour display when looping through from one device to the next.

Other bus door loudspeakers with video are connected with bus video distributors BVVU 650-... or BVVS 650-...

### Supplementary functions

• **Internal speech communication** between bus indoor devices is only possible internally within the same line.

• **Connection of bus telephones** AIB 150-.../BTS/BTC/BFC 850-... or devices for switching and control functions via bus audio decoupler BAA 650-...

Connection of the audio indoor station Standard SI 4 A .. takes place using BAA 650-...  
For more information, see page 64

• **Switching and control functions** are possible with the bus switching modules BSM/BSE/BEM 650-..., feedback to the deluxe bus indoor devices and Jung indoor devices can be programmed.

Connection of the audio indoor station Standard SI 4 A .. takes place using BAA 650-...  
For more information, see page 123

• **Bus secondary signal unit** BNS 750-... possible.

For more information, see page 132

• **Parallel door and storey call**

Up to 8 video indoor stations can be called simultaneously via one bell button.

Up to 4 audio indoor stations can be called simultaneously via one bell button without an additional supply. Only possible within a line.

• **Selective dialling of the door station** possible via additional free buttons.

### Remarks

**a)** The TR 603-... (12 V AC, 1.3 A) can supply the door release, camera heating and max. 30 bus call button modules.

Where more bus call button modules are used, an additional TR 603-... is required for the door release.

**b)** Door release/light contact load in the bus video line rectifier BVNG 650-... max. 15 V AC, 30 V DC, 2 A.

**c)** Door release 12 V AC, use at least 20 Ohm (e.g. TÖ 615-...).  
For more information, see page 126

**d)** Conductor length bus indoor device – storey call button ERT max. 50 m.

**e)** Every Jung video indoor station must be supplied with direct voltage of (22–30 V DC, 170 mA). The NG 706-30/33-... can be used for this purpose.

For more information, see page 131

### 6.3 Siedle Systemtechnik installation

Jung audio & video indoor station

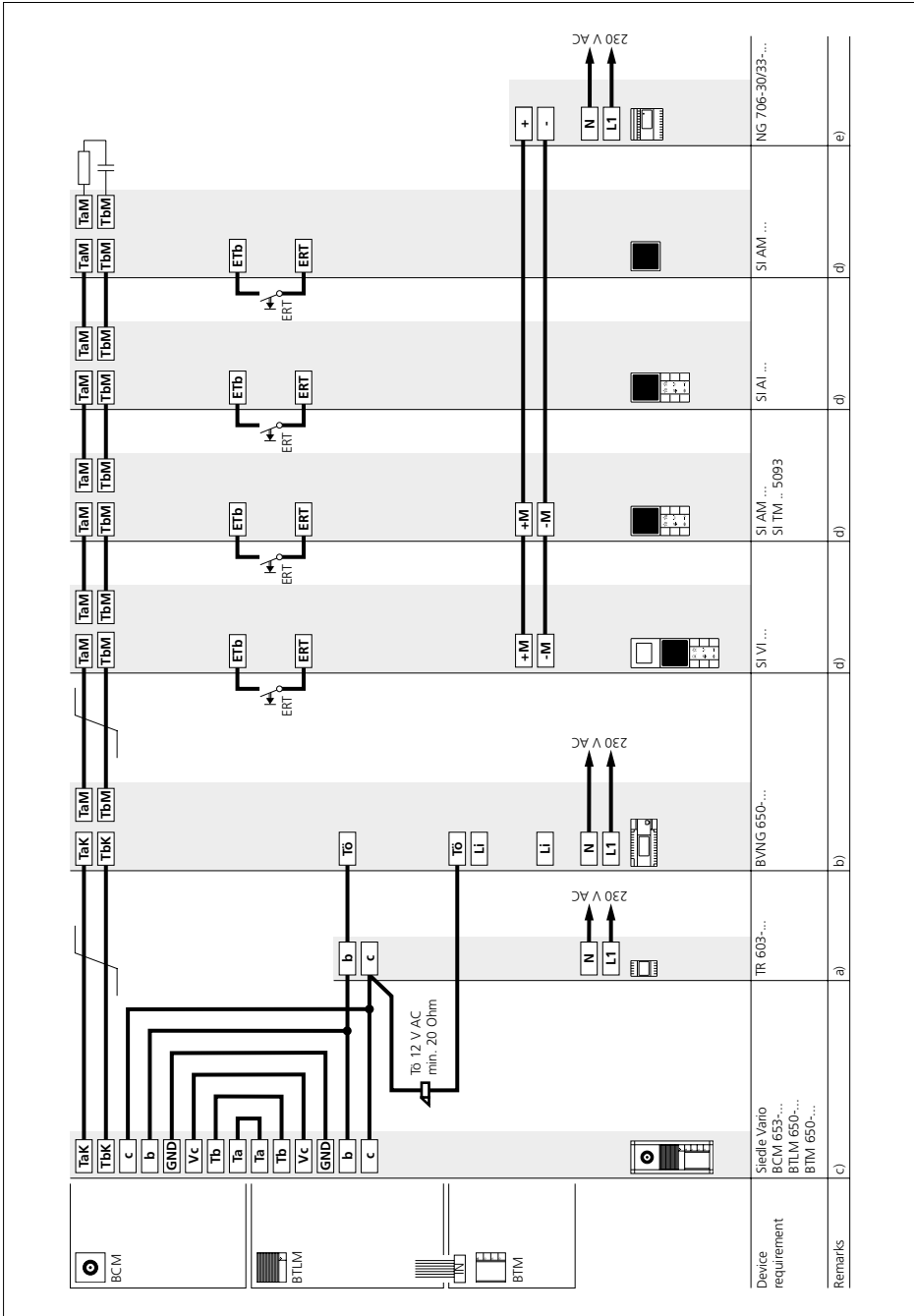

**Jung audio & video indoor station**

**Functional**

Calling, speech and video functions between door station and the connected Jung video indoor stations. Calling and speech between door station and the connected Jung audio indoor stations. Audio and video privacy of existing calls from other bus indoor devices is assured. Door release button for the door release function, light button for the light switching function. Pressing the picture connection button will show the camera picture from the door station which placed the last door call. This function is only possible if no call exists. Connection of a storey call button (ERT) for calling from an apartment door. Ringtones can be selected for calls from the front door, apartment door or internal calls. Connection of other bus indoor devices with colour display when looping through from one device to the next. Other bus door loudspeakers with video are connected with bus video distributors BVVU 650-... or BVVS 650-...

**Supplementary functions**

- **Internal speech communication** between bus indoor devices is only possible internally within the same line.
- **Connection of bus telephones** AIB 150-.../BTS/BTC/BFC 850-... or devices for switching and control functions via bus audio decoupler BAA 650-... Connection of the audio indoor station Standard SI 4 A .. takes place using BAA 650-... For more information, see page 64
- **Switching and control functions** are possible with the bus switching modules BSM/BSE/BEM 650-..., feedback to the deluxe bus indoor devices and Jung indoor devices can be programmed. Connection of the audio indoor station Standard SI 4 A .. takes place using BAA 650-... For more information, see page 123
- **Bus secondary signal unit** BNS 750-... possible. For more information, see page 132
- **Parallel door and storey call** Up to 8 video indoor stations can be called simultaneously via one bell button. Up to 4 audio indoor stations can be called simultaneously via one bell button without an additional supply. Only possible within a line.
- **Selective dialling of the door station** possible via additional free buttons.

**Remarks**

- a)** The TR 603-... (12 V AC, 1.3 A) can supply the door release, camera heating and max. 30 bus call button modules. Where more bus call button modules are used, an additional TR 603-... is required for the door release.
- b)** Door release/light contact load in the bus video line rectifier BVNG 650-... max. 15 V AC, 30 V DC, 2 A.
- c)** Door release 12 V AC, use at least 20 Ohm (e.g. TÖ 615-...). For more information, see page 126
- d)** Conductor length bus indoor device – storey call button ERT max. 50 m.
- e)** Every Jung video indoor station must be supplied with direct voltage of (22–30 V DC, 170 mA). The NG 706-30/33-... can be used for this purpose. For more information, see page 131

### 6.3 Siedle Systemtechnik installation

Jung standard audio indoor station & video indoor station

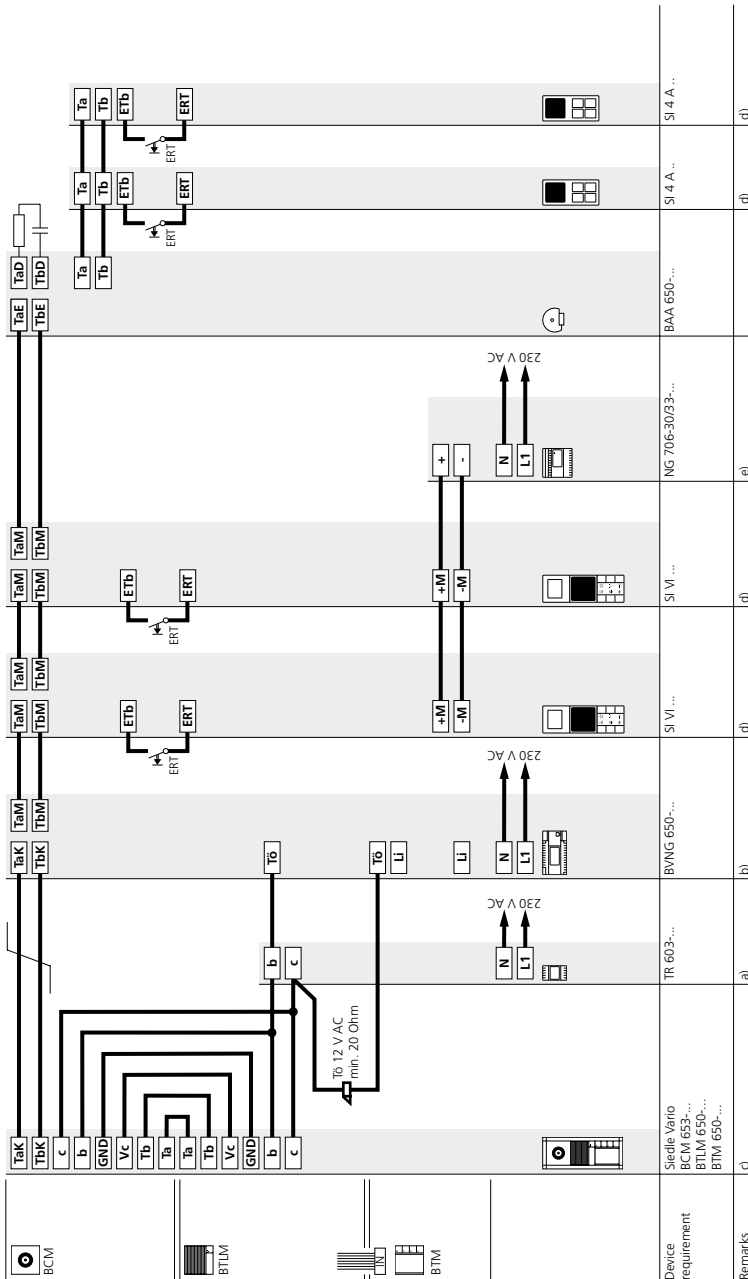

**Jung standard audio indoor station & video indoor station**

**Functional**

Calling, speech and video functions between door station and the connected Jung video indoor stations. Calling and speech between door station and the connected Jung audio indoor stations.

Audio and video privacy of existing calls from other bus indoor devices is assured. Door release button for the door release function, light button for the light switching function.

Pressing the picture connection button will show the camera picture from the door station which placed the last door call. This function is only possible if no call exists.

Connection of a storey call button (ERT) for calling from an apartment door. Ringtones can be selected for calls from the front door, apartment door or internal calls.

Connection of other bus indoor devices with colour display when looping through from one device to the next.

Other bus door loudspeakers with video are connected with bus video distributors BVVU 650-... or BVVS 650-...

**Supplementary functions**

• **Internal speech communication** between bus indoor devices is only possible internally within the same line.

• **Connection of bus telephones** AIB 150-.../BTS/BTC/BFC 850-... or devices for switching and control functions via bus audio decoupler BAA 650-...

Connection of the audio indoor station Standard SI 4 A .. takes place using BAA 650-...  
For more information, see page 64

• **Switching and control functions** are possible with the bus switching modules BSM/BSE/BEM 650-..., feedback to the deluxe bus indoor devices and Jung indoor devices can be programmed.

Connection of the audio indoor station Standard SI 4 A .. takes place using BAA 650-...  
For more information, see page 123

• **Bus secondary signal unit** BNS 750-... possible.  
For more information, see page 132

• **Parallel door and storey call** Up to 8 video indoor stations can be called simultaneously via one bell button.

Up to 4 audio indoor stations can be called simultaneously via one bell button without an additional supply. Only possible within a line.

• **Selective dialling of the door station** possible via additional free buttons.

**Remarks**

**a)** The TR 603-... (12 V AC, 1.3 A) can supply the door release, camera heating and max. 30 bus call button modules.

Where more bus call button modules are used, an additional TR 603-... is required for the door release.

**b)** Door release/light contact load in the bus video line rectifier BVNG 650-... max. 15 V AC, 30 V DC, 2 A.

**c)** Door release 12 V AC, use at least 20 Ohm (e.g. TÖ 615-...).  
For more information, see page 126

**d)** Conductor length bus indoor device – storey call button ERT max. 50 m.

**e)** Every Jung video indoor station must be supplied with direct voltage of (22–30 V DC, 170 mA). The NG 706-30/33-... can be used for this purpose.  
For more information, see page 131

### 6.3 Siedle Systemtechnik installation

Siedle and Jung indoor stations combined

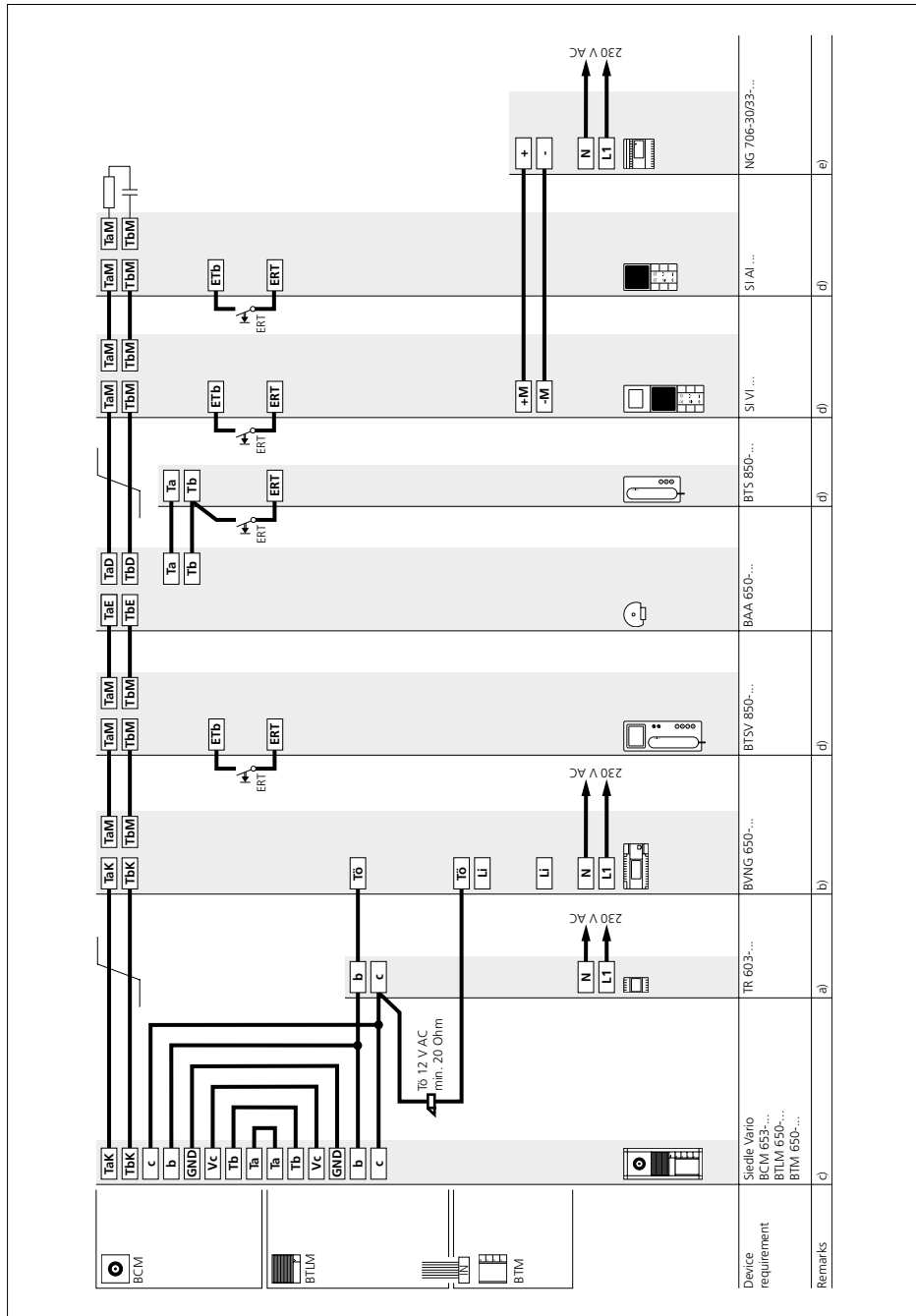

## Siedle and Jung indoor stations combined

### Functional

Calling, speech and video functions between door station and the connected video indoor stations.

Calling and speech between door station and the connected audio indoor stations.

Audio and video privacy of existing calls from other bus indoor devices is assured. Door release button for the door release function, light button for the light switching function.

Pressing the picture connection button will show the camera picture from the door station which placed the last door call. This function is only possible if no call exists.

Connection of a storey call button (ERT) for calling from an apartment door. Ringtones can be selected for calls from the front door, apartment door or internal calls.

Connection of other bus indoor devices with colour display when looping through from one device to the next.

Other bus door loudspeakers with video are connected with bus video distributors BVVU 650-... or BVVS 650-...

### Supplementary functions

• **Internal speech communication** between bus indoor devices is only possible internally within the same line.

• **Connection of bus telephones** AIB 150-.../BTS/BTC/BFC 850-... or devices for switching and control functions via bus audio decoupler BAA 650-...

Connection of the audio indoor station Standard SI 4 A .. takes place using BAA 650-...  
For more information, see page 64

• **Switching and control functions** are possible with the bus switching modules BSM/BSE/BEM 650-..., feedback to the deluxe bus indoor devices and Jung indoor devices can be programmed.

Connection of the audio indoor station Standard SI 4 A .. takes place using BAA 650-...  
For more information, see page 123

• **Bus secondary signal unit** BNS 750-... possible.

For more information, see page 132

• **Parallel door and storey call**

Up to 8 video indoor stations can be called simultaneously via one bell button.

Up to 4 audio indoor stations can be called simultaneously via one bell button without an additional supply. Only possible within a line.

• **Selective dialling of the door station** possible via additional free buttons.

### Remarks

**a)** The TR 603-... (12 V AC, 1.3 A) can supply the door release, camera heating and max. 30 bus call button modules.

Where more bus call button modules are used, an additional TR 603-... is required for the door release.

**b)** Door release/light contact load in the bus video line rectifier BVNG 650-... max. 15 V AC, 30 V DC, 2 A.

**c)** Door release 12 V AC, use at least 20 Ohm (e.g. TÖ 615-...).  
For more information, see page 126

**d)** Conductor length bus indoor device – storey call button ERT max. 50 m.

**e)** Every Jung video indoor station must be supplied with direct voltage of (22–30 V DC, 170 mA). The NG 706-30/33-... can be used for this purpose.

For more information, see page 131

## 7 Programming

### Overview of functions

Functions with Siedle In-Home and programming possibilities. Terms used in the table are explained in detail on the next page.

- not available
- /-/ Plug+Play programming
- /•/- Manual programming
- /-/• PC programming

\* (from V 4.0)

#### Basic functions

	AIB 150-01	BTS 850-...	BTC 850-...	BFC 850-...
Door call	•/•/•	•/•/•	•/•/•	•/•/•
-Storey call				
-Door release button				
-Light button				
-Call silencing and display (Functional following installation)				
Dialling last door (Functional following installation)	-/-/•	-/-/•	-/-/•	-/-/•
Call tone configuration	-/•/•	-/•/•	-/•/•	-/•/•
Setting at the bus indoor device				
<b>Supplementary functions</b>				
BSE Groups	-/-/•	-/-/•	-/-/•	-/-/•
Group formation	-/•/•	-/-/•	-/-/•	-/-/•
Internal call	-	-/•/•	-/•/•	-/•/•
Camera step	-	-	-	-
Secondary signal unit	-/-/•	-/•/•	-/•/•	-/•/•
Parallel device	-/-/•	-/•/•	-/•/•	-/•/•
Status display (via LED)	-	-	-/-/•	-/-/•
Control function	-/-/•	-/-/•	-/•/•	-/•/•
Door dialling	-	-/•/•	-/•/•	-/•/•
Doormatic	-	-	-/-/•	-/-/•
Door call acceptance	-	-/-/•	-/-/•	-/-/•
Door call forwarding	-	-	-/-/•	-/-/•
Time for light contact	-/-/•	-/-/•	-/-/•	-/-/•
Second button level	-/-/•	-/-/•	-/-/•	-/-/•
<b>Intercom functions</b>				
Internal group call	-	-	-/-/•	-/-/•
Collective announcement*	-	-	-	-/-/•
Automatic call acceptance	-	-	-	-/-/•
Set call-back	-	-	-/-/•	-/-/•
Receive callback	-	-	-/-/•	-/-/•



<b>Basic functions</b>	<b>VIB 150-...</b>	<b>BTSV 850-...</b>	<b>BTCV 850-...</b>	<b>BVPC 850-...</b>	<b>SG 150-... + App</b>	<b>SG 650-... + App</b>
Door call	●/●/●	●/●/●	●/●/●	●/●/●	-/●/●	-/●/●
-Storey call						
-Door release button						
-Light button						
-Call silencing and display (Functional following installation)						
Dialling last door (Functional following installation)	-/-/●	-/-/●	-/-/●	-/-/●	-/●/●	-/●/●
Call tone configuration	-/●/●	-/●/●	-/●/●	-/●/●	-	-
Setting at the bus indoor device						
<b>Supplementary functions</b>						
BSE Groups	-/-/●	-/-/●	-/-/●	-/-/●	-	-
Group formation	-/●/●	-/-/●	-/-/●	-/-/●	-/-/●	-/-/●
Internal call	-	-/●/●	-/●/●	-/-/●	-/-/●	-/-/●
Camera step	-	-/-/●	-/-/●	-/-/●	-	-
Secondary signal unit	-/-/●	-/●/●	-/●/●	-/●/●	-/-/●	-/-/●
Parallel device	-/-/●	-/●/●	-/●/●	-/●/●	-/-/●	-/-/●
Status display (via LED)	-	-	-/-/●	-/-/●	-	-
Control function	-/-/●	-/-/●	-/●/●	-/-/●	-	-
Door dialling	-	-/●/●	-/●/●	-/-/●	-/-/●	-/-/●
Doormatic	-	-	-/-/●	-/-/●	-	-
Door call acceptance	-	-/-/●	-/-/●	-	-	-
Door call forwarding	-	-	-/-/●	-/-/●	-	-
Time for light contact	-/-/●	-/-/●	-/-/●	-/-/●	-/-/●	-/-/●
Second button level	-/-/●	-/-/●	-/-/●	-	-	-
<b>Intercom functions</b>						
Internal group call	-	-	-/-/●	-/-/●	-	-
Collective announcement*	-	-	-	-/-/●	-	-
Automatic call acceptance	-	-	-	-/-/●	-	-
Set call-back	-	-	-/-/●	-/-/●	-	-
Receive callback	-	-	-/-/●	-/-/●	-	-

## 7 Programming

### Overview of functions

Functions with Siedle In-Home and programming possibilities. Terms used in the table are explained in detail on the next page.

- not available
- /-/ Manual programming
- /•/- Manual programming
- /-/• PC programming

#### Basic functions

	SI 4 A..	SI A1 ...	SI VI ...
Door call	•/•/•	•/•/•	•/•/•
-Storey call			
-Door release button			
-Light button			
-Call silencing and display (Functional following installation)			
Dialling last door (Functional following installation)	-/-/•	-/-/•	-/-/•
Call tone configuration	-/•/•	-/•/•	-/•/•
Setting at the bus indoor device			

#### Supplementary functions

BSE Groups	-/-/•	-/-/•	-/-/•
Group formation	-/-/•	-/-/•	-/-/•
Internal call	-/•/•	-/•/•	-/•/•
Camera step	-	-	-/-/•
Secondary signal unit	-/•/•	-/•/•	-/•/•
Parallel device	-/•/•	-/•/•	-/•/•
Status display (via LED)	-/-/•	-/-/•	-/-/•
Control function	-/•/•	-/•/•	-/•/•
Door dialling	-/•/•	-/•/•	-/•/•
Doormatic	-	-/-/•	-/-/•
Door call acceptance	-/-/•	-/-/•	-/-/•
Door call forwarding	-	-/-/•	-/-/•
Time for light contact	-/-/•	-/-/•	-/-/•
Second button level	-	-	-

#### Intercom functions

Internal group call	-	-/-/•	-/-/•
Collective announcement	-	-	-/-/•
Automatic call acceptance	-	-/-/•	-/-/•
Set call-back	-	-/-/•	-/-/•
Receive call-back	-	-/-/•	-/-/•



## 7 Programming

### Overview of functions

#### **Dialling last door**

The door station from which the last door call was placed can be dialled by double clicking the light button.

#### **Automatic call acceptance**

The handsfree indoor device automatically picks up incoming internal calls and switches on the speech connection.

#### **BSE Groups**

Several bus switching units are assigned to a group. This allows several BSE 650-... units to be executed simultaneously with one switching contact, e.g. shutter control.

#### **Storey call**

The storey call button (ERT) is used to call into the apartment from an apartment door. Application e.g. apartment building with 4 apartments and a common staircase. Storey call buttons are installed in front of every apartment front door.

#### **Group formation**

Several bus indoor devices are assigned to a group. This allows up to 8 bus indoor devices to be called with one button. A bus indoor device can belong to up to 4 different groups.

#### **Intercom**

The term Intercom denotes internal communication within one building. Using handsfree bus indoor devices, intercom communication is particularly simple and convenient, as it does not require a receiver to be lifted.

#### **Internal call**

Bus indoor devices can place calls to each other using the buttons. Using the standard indoor device, 4 users can be called. The deluxe indoor devices are able to call up to 14 users. Internal calls are only possible within a line.

#### **Internal group call**

Internal call to several indoor devices simultaneously. The device which initially establishes the connection has the call.

#### **Light button**

In the as-delivered status, the light button in the bus indoor device switches the contact in the bus line rectifier for 0.4 seconds. Using the bus programming software BPS 650-... this time can be altered. The function of the light button can be reprogrammed, e.g. for internal calls.

#### **Camera step**

At the button of a bus indoor device BTCV/BVPC 850-... it is possible to dial up to 8 door stations with video or external cameras in sequence. With each actuation, the picture from the next camera is displayed.

#### **Secondary signal unit**

The interfacing relay accessory is available for bus telephones BTS/ BTC 850-... for actuating a signalling device or a lamp. For BFC 850-... use accessory ZARF 850-... A bus secondary signal unit BNS 750-... can be programmed in parallel to a bus indoor device.

#### **Parallel device**

Max. 8 bus indoor devices can ring simultaneously when actuating a doorbell button.

#### **Call silencing and display**

The call can be switched off at the bus indoor devices. Deactivation is signalled at the device.

#### **Call tone configuration**

At each bus indoor device, different call tones can be selected for every call type (door call, internal call, storey call).

#### **Receive callback**

If you are available to accept an internal call, a callback can be requested. This is optically signalled at the deluxe indoor device. This function can be programmed at all deluxe bus indoor devices.

#### **Set call-back**

If you make an internal call and the user does not pick up, you can request a callback. To do this, press the flashing button twice.

#### **Collective announcement**

Paging announcement to one or more deluxe handsfree devices (from V 4.0). Can be used for instance for making an announcement in a waiting room or for searching for individual personnel in a building.

#### **Status display (via LED)**

The supplementary devices bus switching module BSE 650-... and bus input module BEM 650-... send feedback signals to the In-Home bus. These can be displayed at the bus indoor devices, e.g. whether the garage door is open.

#### **Control function**

The supplementary devices bus switching unit BSE 650-..., bus input module BEM 650-... and bus switching module BSM 650-... can execute different switching and control functions for individual operations.

**Teach-in**

Term for manual programming of bus users.

**Door dialling**

One or more door stations can be selectively dialled and a speech connection established.

**Doormatic**

The door release contact in the bus video line rectifier and in the calling bus door loudspeaker switches for 3 seconds after the door bell button has been pressed. The function can be actively switched from the deluxe bus indoor device.

**Door release button**

The door release button on the bus indoor device always switches the DR contact at the bus line rectifier for 3 seconds and the DR contact in the door loudspeaker which placed the call.

**Door call**

When a visitor presses the door bell button, the bus telephone rings and the call silencing button flashes. In handsfree bus telephones, the speech button flashes.

**Door call acceptance**

A door call from a bus telephone can be accepted in a different room.

**Door call forwarding**

The door call can be re-routed from a deluxe bus indoor device by pressing a button to a different bus indoor device, e.g. rerouting of a door call from the secretary to the caretaker. The bus indoor devices must be located in the same line.

**Time for light contact**

The switching time of the light contact is 0.4 seconds in the as-delivered status. This time can be altered using the bus programming software BPS 650-... from V 2.50.

## 7 Programming

### Remarks

The In-Home bus can be programmed in three ways:

#### 1 Programming – manual

For more information, see page 86

#### 2 Programming – Plug+Play

For more information, see page 118

#### 3 Programming – with PC

For more information, see page 122

#### Important remarks prior to programming

- The entire installation must have been completed. When programming using the Plug+Play method, the housing of the bus indoor devices must not yet be closed.
- Before starting programming, all buttons should be inscribed to allow them to be assigned to the relevant bus indoor devices.
- It is only ever possible to activate one door loudspeaker in the programming mode.
- If an already programmed call button is pressed for longer than 3 seconds in the programming mode at the activated door loudspeaker, after one second a warning tone is sounded, and after 3 seconds the confirmation tone. After this, the call button is deleted if there was no bus indoor device active. However, if there is a bus indoor device active at this moment, the button is overwritten with the new address.
- All BNG/BVNG 650-... units must be connected to mains voltage of 230 V AC.
- In multiple line systems with several BNG/BVNG 650-... units, actuating the Prog. mode button **at one** BNG/BVNG 650-... switches all other connected BNG/BVNG 650-... units to the programming mode.
- In multiple line systems, at each BNG/BVNG 650-... **a different address** must be set. **The number "0" cannot be used as an address!**

- In multiple line systems bus power supply accessory ZBVG 650-... must be additionally plugged into one BNG/BVNG 650-... The bus video line rectifier accessory ZBVNG 650-... must be plugged into each BVNG 650-...

#### Programming – manual

##### Procedure:

On principle, the In-Home bus can be commissioned and programmed by one person. However, as work has to be executed both at the door loudspeaker and the bus indoor device, we recommend that commissioning be carried out by two people for larger-scale projects.

- Complete the installation
- Check the switch positions at the BNG/BVNG 650-..., in new systems set the switch setting to Norm.
- Activate the programming mode at the bus line rectifier
- Set the door station to the programming mode
- Program the users
- Quit the programming mode

While the bus line rectifier is in the programming mode, several steps can be programmed in sequence. There is no need to quit the programming mode after every operation.

#### Handsfree bus telephones

Picking up and replacing the receiver are no longer necessary when using handsfree bus telephones AIB/VIB 150-.../BFC/BVPC 850-...

The AIB/VIB 150-... switch to the programming mode by pressing the speech button.

The BFC 850-... switch to the programming mode by pressing the light button.

Once the programming step has been performed, the device switches back to the idle status. All other programming steps are identical.

#### Bus video panel

With the BVPC 850-... the programming mode is activated via the menu user interface. Tab:

- > Settings
- > Installation
- > Start programming mode
- > Start.

The device is then switched to the programming mode. Once the programming step has been performed, the device switches back to the idle status. All other programming steps are identical.

## 7.1 Programming – manual

### Activating the bus line rectifier

To activate the programming mode at the bus line rectifier, the programming mode button has to be briefly pressed down. LED 1 indicates whether the programming mode is switched on. After activating the programming mode, LED 1 changes

over from normal mode to programming mode.

#### Indication at LED 1 Function display

LED flashes briefly **0.02 seconds** – long pause **1 second**

■ Pause ■ Pause ■ Pause ■ etc.

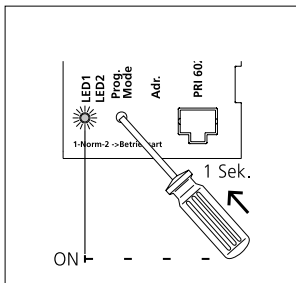

Using a small screwdriver, set the bus line rectifier to the programming mode through the opening in the cover.

#### Note:

If no programming process takes place within 10 minutes, the BNG 650-... switches back to the standard operating mode.

#### Indication at LED 1 Programming mode active

LED flashes briefly **0.3 seconds** – long pause **2 seconds**

■ Pause ■ Pause ■ etc.

## 7.1 Programming – manual

### Activating the bus door loudspeaker

Depending on the type of door station, the programming mode has to be activated in a different way.

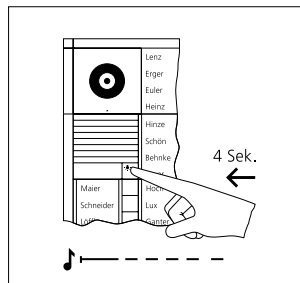

#### 1 Siedle Vario

In the case of door loudspeaker module BTLM 650-... the programming mode is activated using the light button. Hold down the light button for 4 seconds until a protracted signal tone is audible.

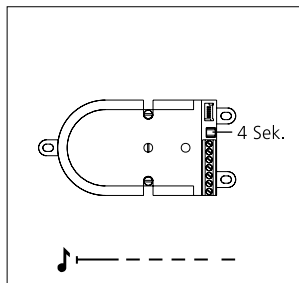

#### 2 Siedle custom-fit door loudspeaker

In the case of the BTLE 050-... the programming mode is activated using the programming button. Next to the terminal, hold down the programming button for 4 seconds until a protracted signal tone is audible.

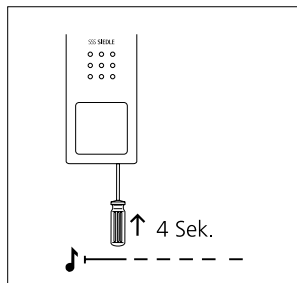

#### 3 Siedle Compact

At the door station, hold down the programming button for 4 seconds. A protracted acknowledgement tone is then audible which is repeated every 5 seconds as long as the programming mode remains active.

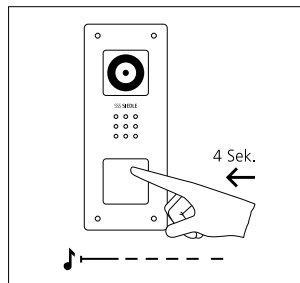

#### 4 Siedle Compact flush mounting

At the door station, hold down the top bell button for 4 seconds. A protracted acknowledgement tone is then audible which is repeated every 5 seconds as long as the programming mode remains active.

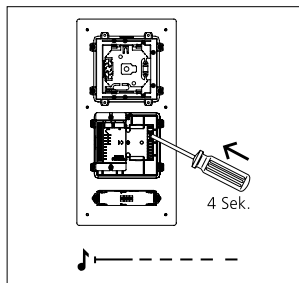

#### 5 Siedle Classic

On the door station, press and hold the programming button behind the front panel for 4 seconds. A sustained acknowledgement tone will sound, which briefly repeats every 5 seconds while programming mode is active.

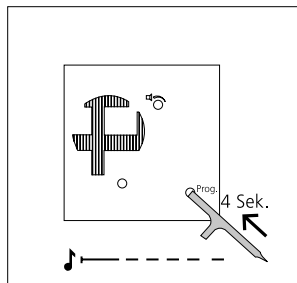

#### 6 Siedle Steel

The programming button is only accessible with the operating panel removed. To actuate the programming button, use the blunt end of the plastic key inserted in the inspection shaft cover. Hold down the light button for 4 seconds until a protracted signal tone is audible.



## Activating the indoor devices

Depending on the type of bus indoor device, the programming mode has to be activated in a different way.

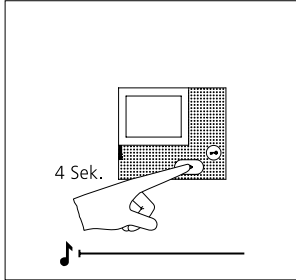

### 1 Siedle Basic

Hold down the speech button for 4 seconds. A protracted acknowledgement tone sounds as confirmation and the muting LED begins to flash. The bus indoor device establishes the speech connection to the door station. The bus indoor device is now in the programming mode.

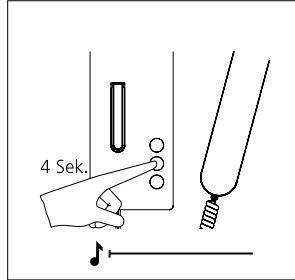

### 2 Bus telephone

Lift the receiver at the bus telephone which you wish to program. Hold down the light button for 4 seconds. A protracted acknowledgement tone is audible in the receiver as confirmation. The bus telephone is now in the programming mode. Do not replace the receiver until after programming has been completed at the bus telephone.

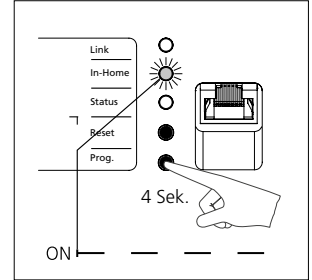

### 3 Smart Gateway/ Smart Gateway Professional

Press the programming button for 4 seconds. The In-Home LED then flashes in a one-second rhythm. The Smart Gateway is now in the programming mode.

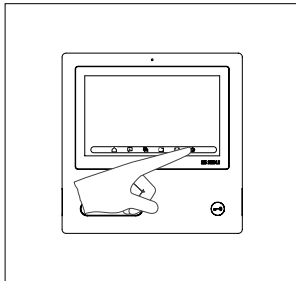

### 4 Bus video panel

Tap Settings; > Installation; > Start Programming; > Start. The bus video panel establishes the speech connection to the door station. The bus video panel is now in the programming mode.

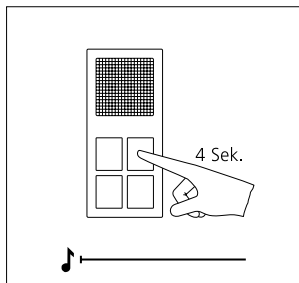

**1 Activate the standard audio indoor station**

Hold down the light button for 4 seconds. A protracted acknowledgement tone sounds as confirmation and the muting button begins to flash. The standard audio indoor station establishes the speech connection to the door station. The standard audio indoor station is now in the programming mode.

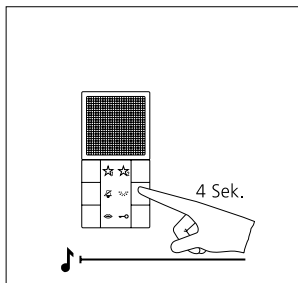

**2 Activate the audio indoor station**

Hold down the light button for 4 seconds. A protracted acknowledgement tone sounds as confirmation and the muting button begins to flash. The audio indoor station establishes the speech connection to the door station. The audio indoor station is now in the programming mode.

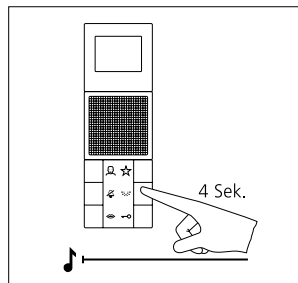

**3 Activate the video indoor station**

Hold down the light button for 4 seconds. A protracted acknowledgement tone sounds as confirmation and the muting button begins to flash. The video indoor station establishes the speech connection to the door station. The video indoor station is now in the programming mode.

## Door call to Siedle Basic

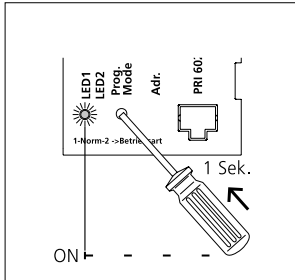

**1** Switch on the programming mode. At the BNG/BVNG 650-..., press the programming mode button briefly. The LED 1 flashes in a 2-second rhythm to indicate that the programming mode is active.

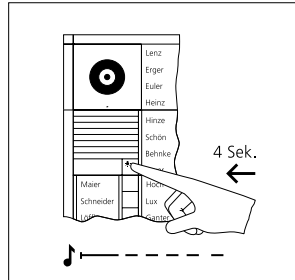

**2** At the door station, hold down the light/programming button for 4 seconds. A protracted acknowledgement tone is then audible which is repeated every 5 seconds as long as the programming mode remains active.

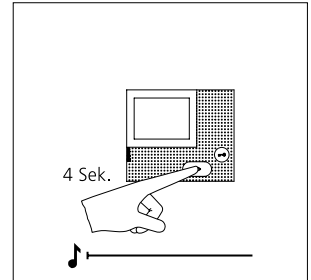

**3** Hold down the speech button for 4 seconds. A protracted acknowledgement tone sounds as confirmation and the muting LED begins to flash. The bus indoor device establishes the speech connection to the door station. The bus indoor device is now in the programming mode.

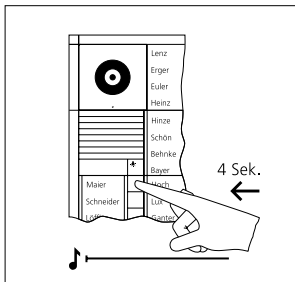

**4** On the door station, press and hold the desired call button for 4 seconds until a sustained tone can be heard from the door loudspeaker. The call button is now assigned to the bus indoor device.

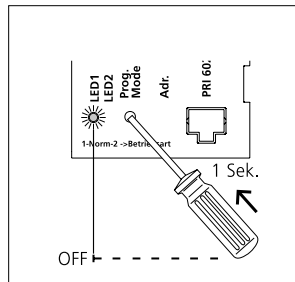

**5** The call button is now firmly assigned to the handsfree bus telephone.

Program additional users using the same procedure or quit the programming mode.

## 7.1 Programming – manual

### Door call to bus telephone

At the bus telephone, a different ringtone optionally be selected.

The volume of the door call can be changed at the bus telephone.

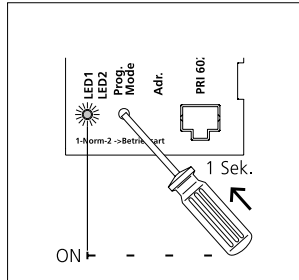

**1** Switch on the programming mode. At the BNG/BVNG 650-..., press the programming mode button briefly. The LED 1 flashes in a 2-second rhythm to indicate that the programming mode is active.

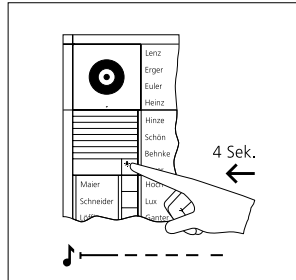

**2** At the door station, hold down the light/programming button for 4 seconds. A protracted acknowledgement tone is then audible which is repeated every 5 seconds as long as the programming mode remains active.

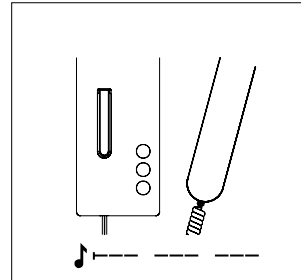

**3** Lift the receiver at the bus telephone which you wish to program.

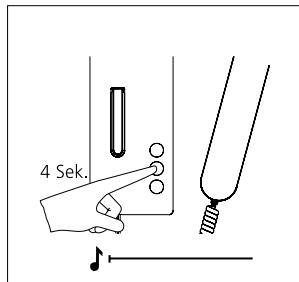

**4** Hold down the light button for 4 seconds. A protracted acknowledgement tone sounds in the receiver, the muting button flashes. A speech connection exists to the door station. The bus telephone is now in the programming mode. Leave the receiver off the hook.

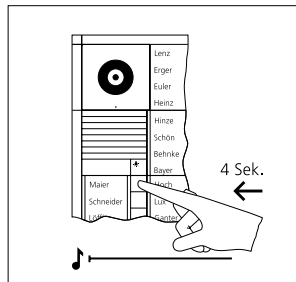

**5** On the door station, press and hold the desired call button for 4 seconds until a sustained tone can be heard from the door loudspeaker. The call button is now assigned to the bus indoor device.

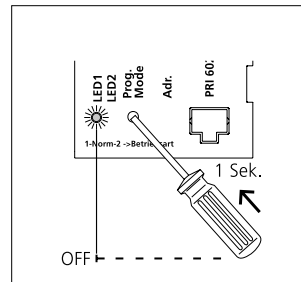

**6** Replace the receiver at the bus telephone. The call button is now firmly assigned to the bus telephone.

Program additional users using the same procedure or quit the programming mode.

## Door call to Smart Gateway/Smart Gateway Professional

Only one bus address can be assigned in the SG 150/650 with manual programming. If more bus addresses are required, PC programming must be selected.

To do so, the PRI 602-... USB programming interface and the BPS 650-... bus programming software is required.

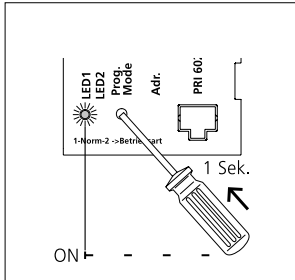

**1** Switch on the programming mode. At the BNG/BVNG 650-..., press the programming mode button briefly. The LED 1 flashes in a 2-second rhythm to indicate that the programming mode is active.

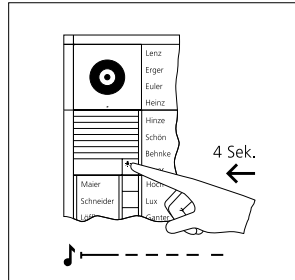

**2** At the door station, hold down the light/programming button for 4 seconds. A protracted acknowledgement tone is then audible which is repeated every 5 seconds as long as the programming mode remains active.

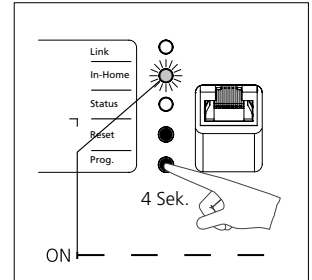

**3** Press the programming button for 4 seconds. The In-Home LED then flashes in a one-second rhythm. The Smart Gateway is now in the programming mode.

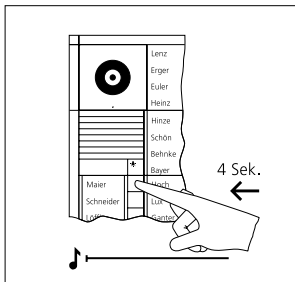

**4** At the door station, hold down the required call button for 4 seconds until a protracted tone sounds at the door loudspeaker.

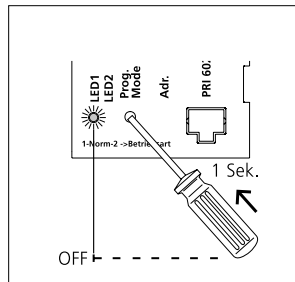

**5** The call button is now firmly assigned to the Smart Gateway/Smart Gateway Professional.

## 7.1 Programming – manual

### Door call Compact to Siedle Basic

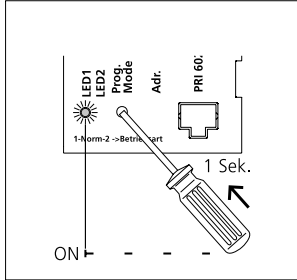

**1** Switch on the programming mode. At the BNG/BVNG 650-..., press the programming mode button briefly. The LED 1 flashes in a 2-second rhythm to indicate that the programming mode is active.

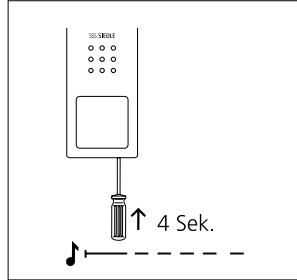

**2** At the door station, hold down the programming button for 4 seconds. A protracted acknowledgement tone is then audible which is repeated every 5 seconds as long as the programming mode remains active.

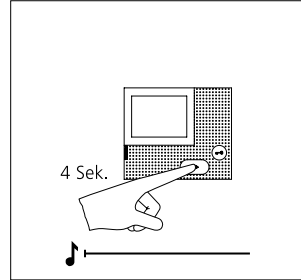

**3** Hold down the speech button for 4 seconds. A protracted acknowledgement tone sounds as confirmation and the muting LED begins to flash. The bus indoor device establishes the speech connection to the door station. The bus indoor device is now in the programming mode.

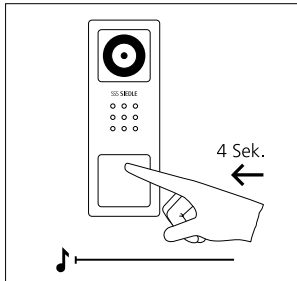

**4** On the door station, press and hold the desired call button for 4 seconds until a sustained tone can be heard from the door loudspeaker. The call button is now assigned to the bus indoor device.

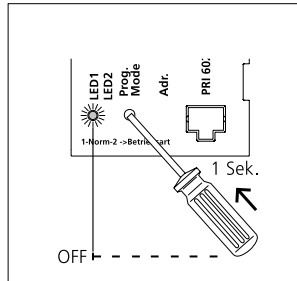

**5** The call button is now firmly assigned to the handsfree bus telephone.

Program additional users using the same procedure or quit the programming mode.

## Door call Compact flush mounting to Siedle Basic

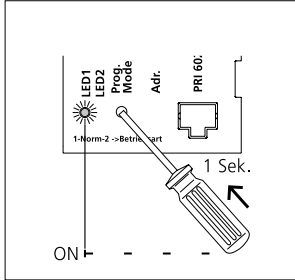

**1** Switch on the programming mode. At the BNG/BVNG 650-..., press the programming mode button briefly. The LED 1 flashes in a 2-second rhythm to indicate that the programming mode is active.

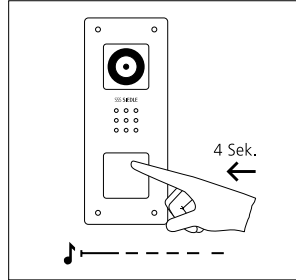

**2** At the door station, hold down the top bell button for 4 seconds. A protracted acknowledgement tone is then audible which is repeated every 5 seconds as long as the programming mode remains active.

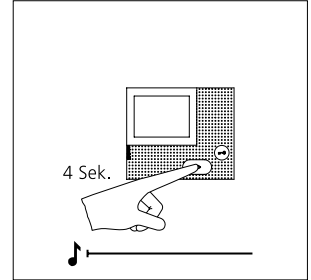

**3** Hold down the speech button for 4 seconds. A protracted acknowledgement tone sounds as confirmation and the muting LED begins to flash. The bus indoor device establishes the speech connection to the door station. The bus indoor device is now in the programming mode.

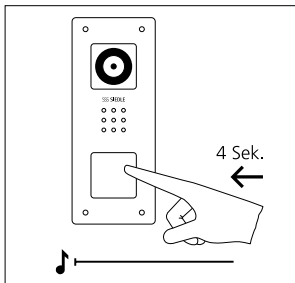

**4** On the door station, press and hold the desired call button for 4 seconds until a sustained tone can be heard from the door loudspeaker. The call button is now assigned to the bus indoor device.

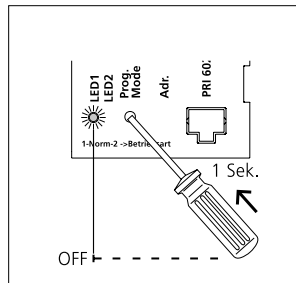

**5** The call button is now firmly assigned to the handsfree bus telephone.

Program additional users using the same procedure or quit the programming mode.

## 7.1 Programming – manual

### Door call to bus video panel

At the bus video panel, a different ringtone can optionally be selected for the door call.

The volume of the door call can be changed at the bus video panel.

The basic configuration must be carried out on every device without fail.

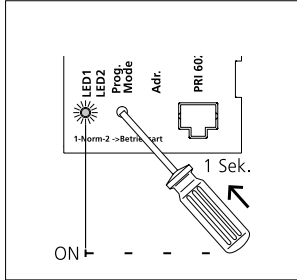

**1** Switch on the programming mode. At the BNG/BVNG 650-..., press the programming mode button briefly. The LED 1 flashes in a 2-second rhythm to indicate that the programming mode is active.

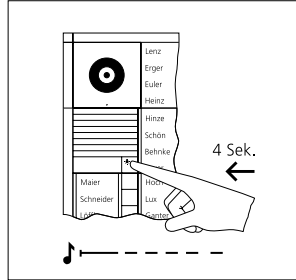

**2** At the door station, hold down the light/programming button for 4 seconds. A protracted acknowledgement tone is then audible which is repeated every 5 seconds as long as the programming mode remains active.

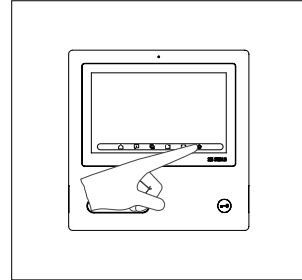

**3** Tap Settings; > Installation; > Start Programming; > Start. The bus video panel establishes the speech connection to the door station. The bus video panel is now in the programming mode.

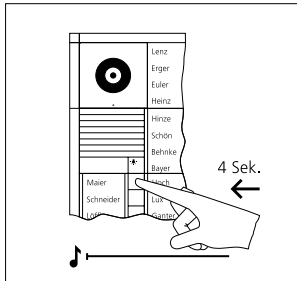

**4** On the door station, press and hold the desired call button for 4 seconds until a sustained tone can be heard from the door loudspeaker. The call button is now assigned to the bus indoor device.

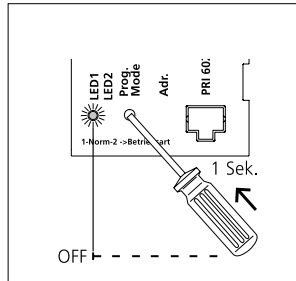

**5** The call button is now firmly assigned to the bus video panel.

Program additional users using the same procedure or quit the programming mode.



## Door call via the storey call button

Programming is only possible when the storey call button (ERT) is connected to the bus indoor device.

If there is no access available to an apartment, programming can still be carried out in this way.

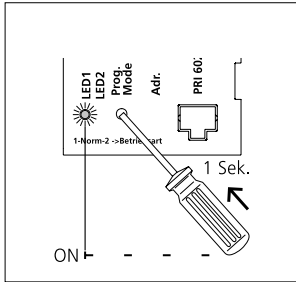

**1** Switch on the programming mode. At the BNG/BVNG 650-..., press the programming mode button briefly. The LED 1 flashes in a 2-second rhythm to indicate that the programming mode is active.

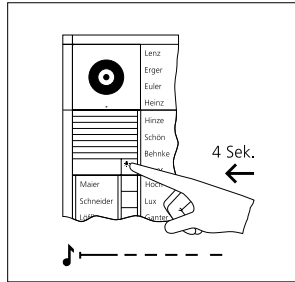

**2** At the door station, hold down the light/programming button for 4 seconds. A protracted acknowledgement tone is then audible which is repeated every 5 seconds as long as the programming mode remains active.

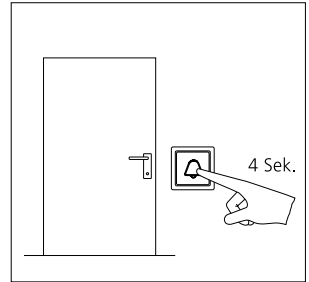

**3** Hold down the storey call button connected to the bus indoor device for 4 seconds. The bus indoor device is now in the programming mode. During this period, no ringing is admissible within the system.

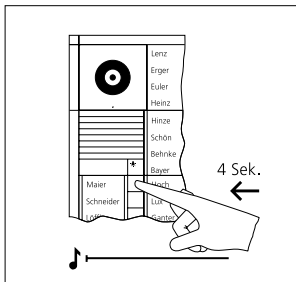

**4** On the door station, press and hold the desired call button for 4 seconds until a sustained tone can be heard from the door loudspeaker. The call button is now assigned to the bus indoor device.

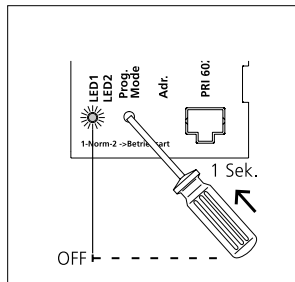

**5** The call button is now firmly assigned to the bus indoor devices. Program additional users using the same procedure or quit the programming mode.

## 7.1 Programming – manual

### Parallel door call

Where a door call has to be signalled at several bus telephones simultaneously.

With more than 1 bus telephone all other bus telephones with colour

monitor must have an additional power supply.

For more information, see page 128

Programming must start at the bus telephone to which no supplementary power supply is connected.

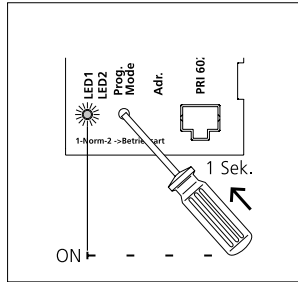

**1** Switch on the programming mode. At the BNG/BVNG 650-..., press the programming mode button briefly. The LED 1 flashes in a 2-second rhythm to indicate that the programming mode is active.

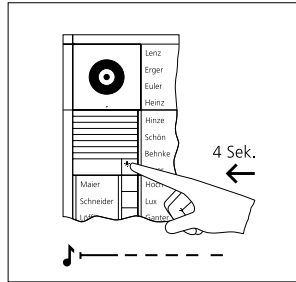

**2** At the door station, hold down the light/programming button for 4 seconds. A protracted acknowledgement tone is then audible which is repeated every 5 seconds as long as the programming mode remains active.

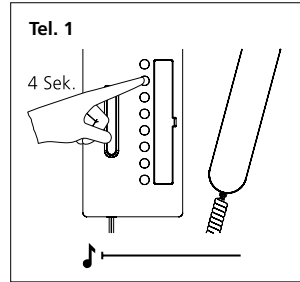

**3** Lift the receiver at the bus telephone which you wish to program. Hold down the light button for 4 seconds. A protracted signal tone is audible in the receiver. A speech connection exists to the door station. The bus telephone is now in the programming mode. Do not replace the receiver!

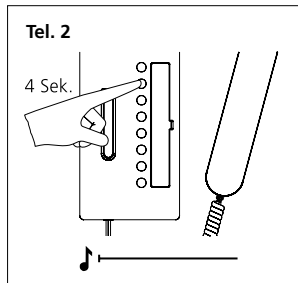

**4** Lift the receiver at the second bus telephone which you wish to program. Hold down the light button for 4 seconds. Do not replace the receiver! Perform the same procedure in all other bus telephones.

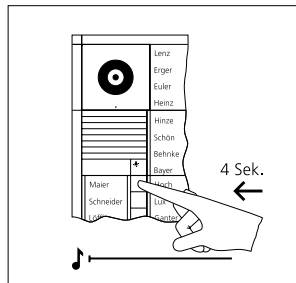

**5** On the door station, press and hold the desired call button for 4 seconds until a sustained tone can be heard from the door loudspeaker. The call button is now assigned to the bus indoor device.

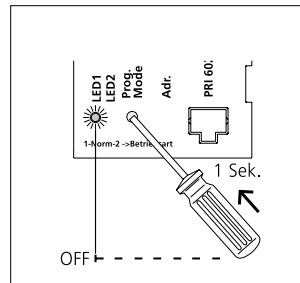

**6** Replace the receiver at all bus telephones which have been programmed. The call button is now firmly assigned to all bus telephones.

Program additional users using the same procedure or quit the programming mode.

## Internal call

You wish a bus telephone to be able to call and communicate with another bus telephone in the system.

An internal call for the BVPC 850-... is programmed at the PC using the bus programming software BPS 650-...

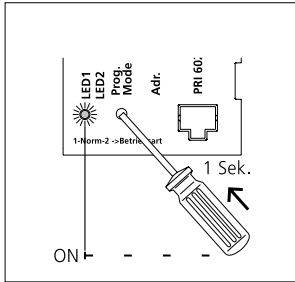

**1** Switch on the programming mode. At the BNG/BVNG 650-..., press the programming mode button briefly. The LED 1 flashes in a 2-second rhythm to indicate that the programming mode is active.

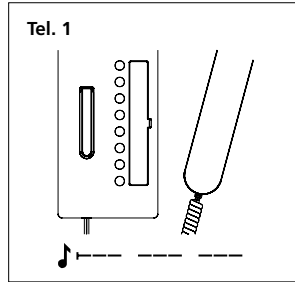

**2** Lift the receiver at the first bus telephone you wish to enable for internal calls. The programming mode tone is audible.

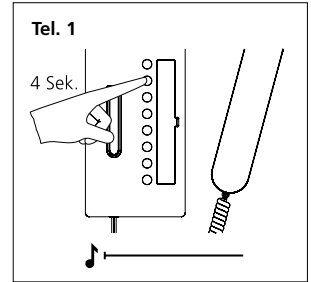

**3** Hold the light button down for 4 seconds. The acknowledgement tone is audible. Do not replace the receiver.

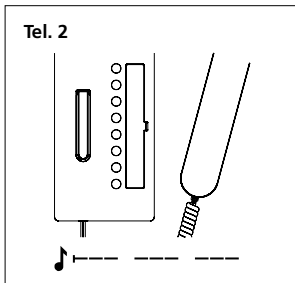

**4** Lift the receiver at the second bus telephone you wish to enable for internal calls. The programming mode tone is audible.

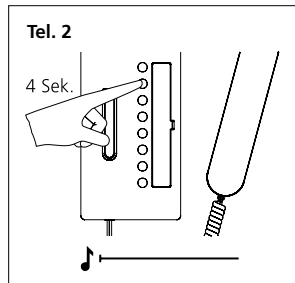

**5** Hold the light button down for 4 seconds. The acknowledgement tone is audible. Do not replace the receiver.

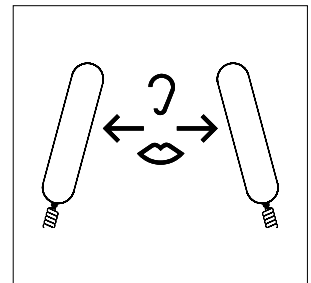

**6** A speech connection now exists between the two bus telephones.

## 7.1 Programming – manual

### Internal call

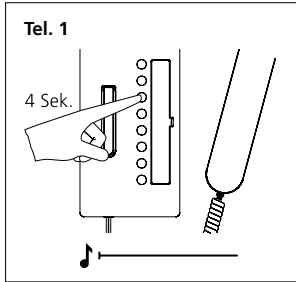

**7** At the first bus telephone, hold down the internal call button you wish to use to call the second bus telephone for 4 seconds. A protracted tone is audible. The bus telephone is now programmed. Do not yet replace the receiver.

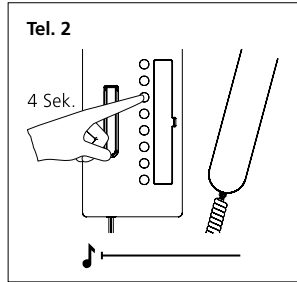

**8** At the second bus telephone, hold down the internal call button you wish to use to call the first bus telephone for 4 seconds. A protracted tone is audible. The buttons are now programmed at both bus telephones.

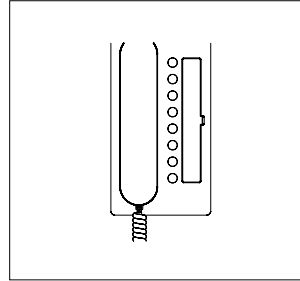

**9** Replace the receiver at both bus telephones. Program additional bus telephones using the same procedure or quit the programming mode.

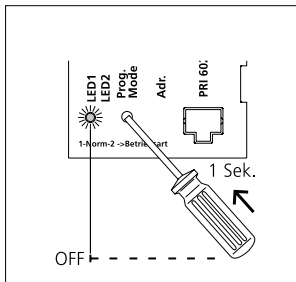

**10** Switch off the programming mode at the BNG/BVNG 650-...

## Dialling the door station

You wish to be able to call one or more door stations from a bus telephone using buttons, e.g. in order to selectively speak to a visitor.

This function can be programmed for any bus telephone to any button. The only exception is the door release button.

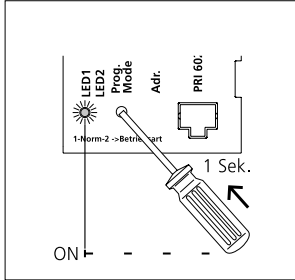

**1** Switch on the programming mode. At the BNG/BVNG 650-..., press the programming mode button briefly. The LED 1 flashes in a 2-second rhythm to indicate that the programming mode is active.

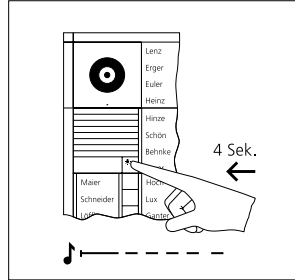

**2** At the door station, hold down the light/programming button for 4 seconds. A protracted acknowledgement tone is then audible which is repeated every 5 seconds as long as the programming mode remains active.

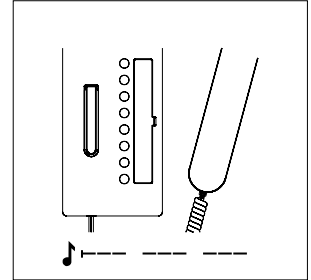

**3** Lift the receiver at the bus telephone which you wish to program.

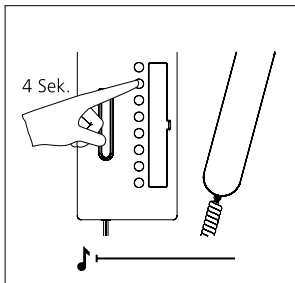

**4** Hold down the light button for 4 seconds. A protracted acknowledgement tone sounds in the receiver, the muting button flashes. A speech connection exists to the door station. The bus telephone is now in the programming mode. Leave the receiver off the hook.

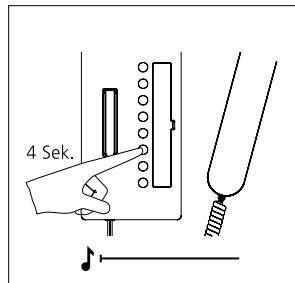

**5** At the bus telephone, hold down the button you wish to use to call the door station for 4 seconds. Replace the receiver. The button is now assigned to the door station. The door loudspeaker can be dialled at any time.

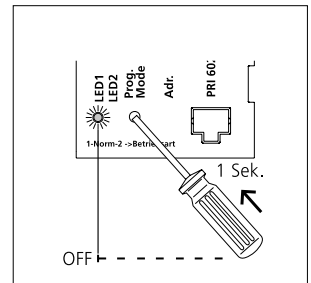

**6** Replace the receiver. Continue to program more bus telephones or quit the programming mode.

## 7.1 Programming – manual

### Selection external camera

The BVM 650-... with switch position 2 is used for connecting an external camera without door station to the Siedle In-Home bus: Video.

External camera dialling can be programmed as a function on a bus telephone button. This function can be programmed for any bus telephone to any button.

The only exception is the door release button.

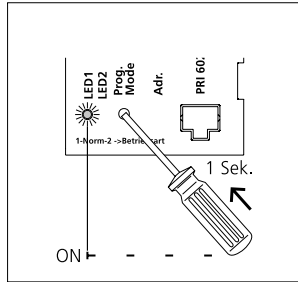

**1** Switch on the programming mode. At the BNG/BVNG 650-..., press the programming mode button briefly. The LED 1 flashes in a 2-second rhythm to indicate that the programming mode is active.

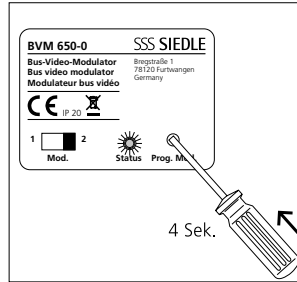

**2** At the BVM 650-... hold the programming button down for 4 seconds. After this, the status LED flashes at short intervals as long as the programming mode is active.

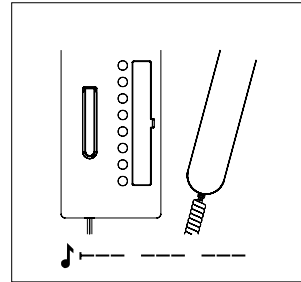

**3** Lift the receiver at the bus telephone which you wish to program.

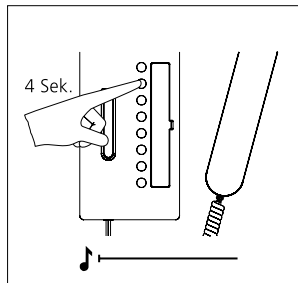

**4** Hold down the light button for 4 seconds. A protracted signal tone is audible in the receiver. The bus telephone is now in the programming mode. Do not replace the receiver! The camera picture can be seen on the monitor.

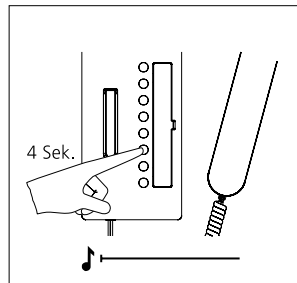

**5** At the bus telephone, hold down the button you wish to use to call the external camera for 4 seconds. Replace the receiver at the bus telephone. The button is now assigned to the external camera. The external camera can be selected at any time.

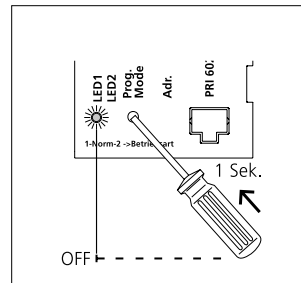

**6** Replace the receiver. Continue to program more bus telephones or quit the programming mode.

## Call differentiation of 2 door stations

At the bus telephone you wish to be able to tell at which door the door call has been made, e.g. whether a door call has come from the main entrance or a side entrance.

Call differentiation can take place from max. 2 doors.

Door call 1 = Tone sequence 1

Door call 2 = Tone sequence 2

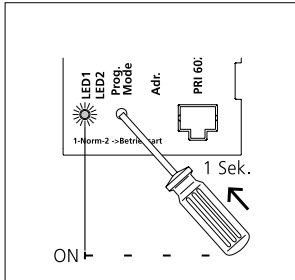

**1** Switch on the programming mode. At the BNG/BVNG 650-..., press the programming mode button briefly. The LED 1 flashes in a 2-second rhythm to indicate that the programming mode is active.

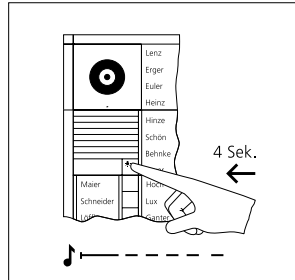

**2** At the door station, hold down the light/programming button for 4 seconds. A protracted acknowledgement tone is then audible which is repeated every 5 seconds as long as the programming mode remains active.

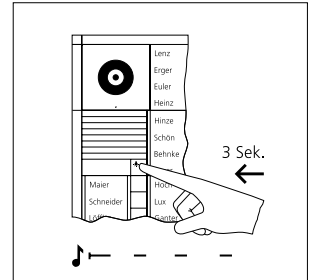

**3** Hold down the light/programming button again for 3 seconds. A short acknowledgement tone is audible. At the bus telephones, a different tone sequence is audible when a call is placed by this door station.

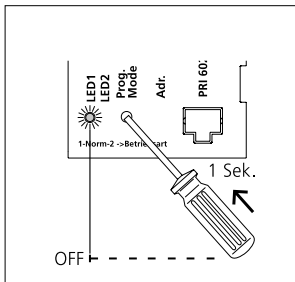

**4** Switch off the programming mode at the BNG/BVNG 650-...

## 7.1 Programming – manual

### Additional contact on the BSM 650-...

The BSM 650-... can only be switched to programming mode if the BNG/BVNG 650-... is in programming mode and no other BSM 650-... is active.

In addition to an already programmed bus telephone, you wish a potential-free switching contact to be closed when a door call is placed. Actuation of an additional bell or

lamp on placement of a door call.

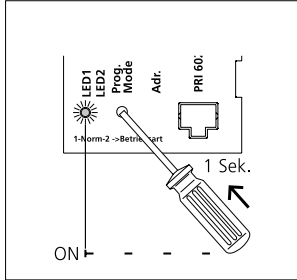

**1** Switch on the programming mode. At the BNG/BVNG 650-..., press the programming mode button briefly. The LED 1 flashes in a 2-second rhythm to indicate that the programming mode is active.

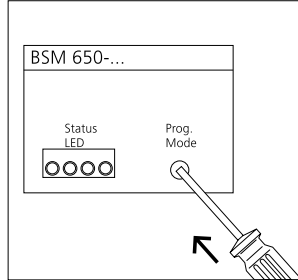

**2** Switch the BSM 650-... to the programming mode. To do this, briefly press the programming mode button using a small screwdriver. LED 1 lights up and flashes slowly after appr. 3 seconds.

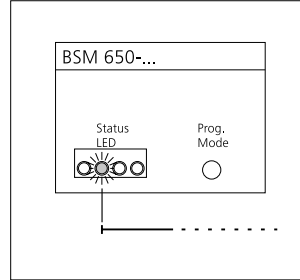

**3** Select the relevant relay by actuating the Prog. mode button at the BSM 650-... with a screwdriver until the required LED lights up (LED2 = relay2, press 2x).

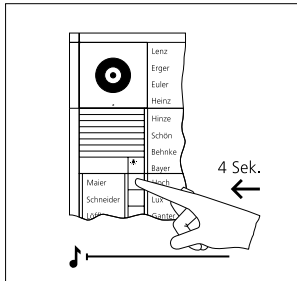

**4** Press the button to which you wish the relay to be assigned and hold down for 4 seconds. A protracted acknowledgement tone is audible in the receiver.

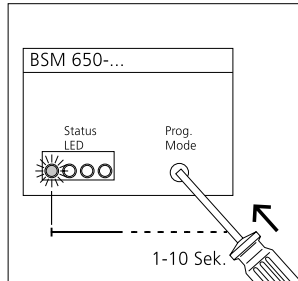

**5** The switching time for the contact is determined by the time for which the screwdriver is held down.

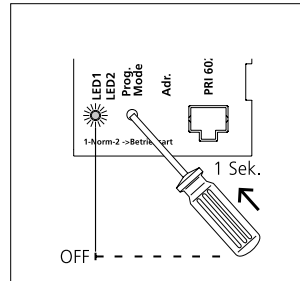

**6** Continue to program more control buttons or quit the programming mode.



## Button of a bus telephone on the BSM 650-...

Actuation of a contact in the BSM 650-..., e.g. in order to open a garage or switch on a staircase light.

In the BVPC 850-..., programming is performed at the PC using bus programming software BPS 650-...

Using the bus programming software BPS 650-... the switching function/time can now be changed.

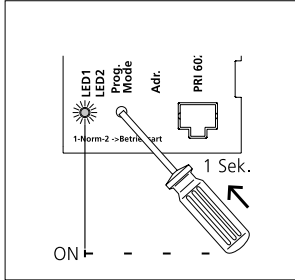

**1** Switch on the programming mode. At the BNG/BVNG 650-..., press the programming mode button briefly. The LED 1 flashes in a 2-second rhythm to indicate that the programming mode is active.

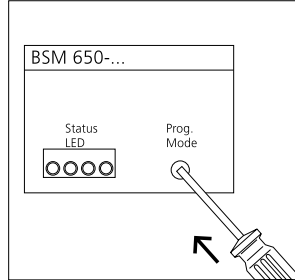

**2** Switch the BSM 650-... to the programming mode. To do this, briefly press the programming mode button using a small screwdriver. LED 1 lights up and flashes slowly after approx. 3 seconds.

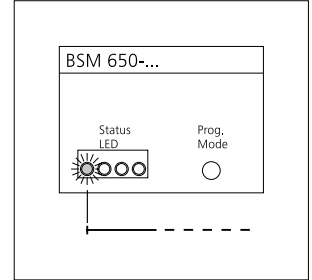

**3** Select the relevant relay by actuating the programming mode button at the BSM 650-... with the screwdriver until the required LED lights up (LED 1=relay 1).

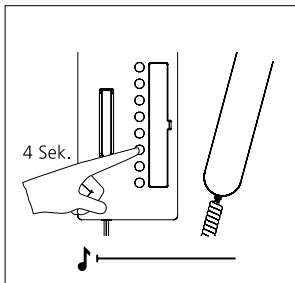

**4** Lift the receiver at the bus telephone at which you wish to program a button. Press the button you wish to program and hold down for 4 seconds. A protracted acknowledgement tone is audible in the receiver.

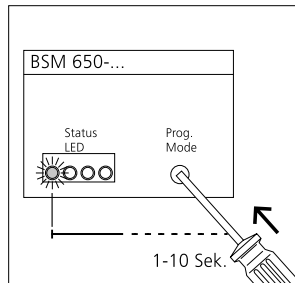

**5** The switching time for the contact is determined by the time for which the screwdriver is held down.

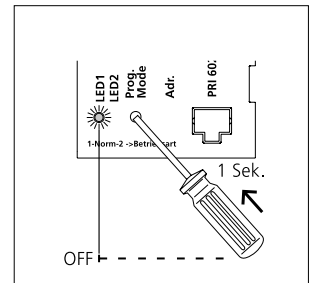

**6** Continue to program more control buttons or quit the programming mode.

## 7.1 Programming – manual

### Deleting the assignment on the BSM 650-...

The assignments on the bus switching module can be deleted in delete mode.

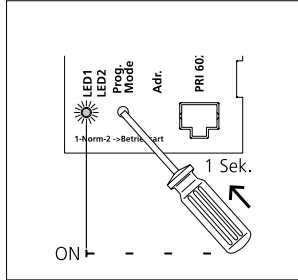

**1** Switch on the programming mode. At the BNG/BVNG 650-..., press the programming mode button briefly. The LED 1 flashes in a 2-second rhythm to indicate that the programming mode is active.

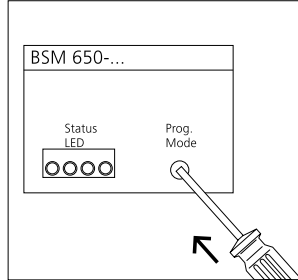

**2** Switch the BSM 650-... to the programming mode. To do this, briefly press the programming mode button using a small screwdriver. LED 1 lights up and flashes slowly after appr. 3 seconds.

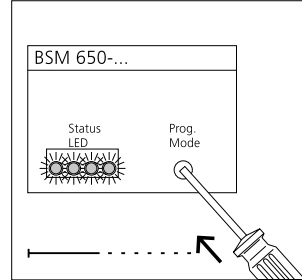

**3** Activate delete mode, to do so press the programming mode button on the BSM 650-... with the screwdriver until all four LEDs light up for 3 seconds and then flash.

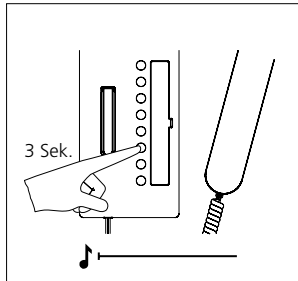

**4** Pick up the receiver on the bus telephone and press the button for which the control function is to be deleted for 3 seconds.

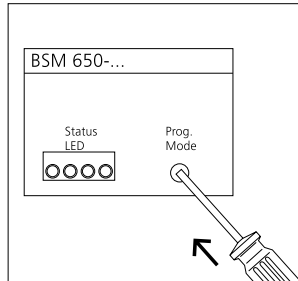

**5** Switch off delete mode on the BSM 650-...

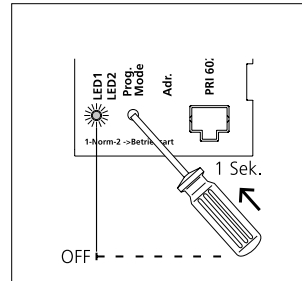

**6** Switch off the programming mode at the BNG/BVNG 650-...



## 7.1 Programming – manual

### Parallel door call to BSE 650-...

The bus telephone must already be programmed to the call button.

Potential-free switching contact which is closed on placement of a door call. Actuation of e.g. a battery-operated chime or additional bell on placement of a door call.

Due to the structure design, the BSE 650-... can be mounted in a 70 junction box.

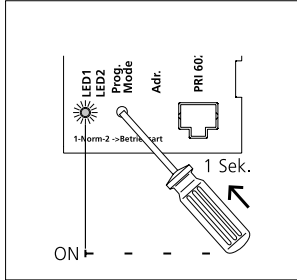

**1** Switch on the programming mode. At the BNG/BVNG 650-..., press the programming mode button briefly. The LED 1 flashes in a 2-second rhythm to indicate that the programming mode is active.

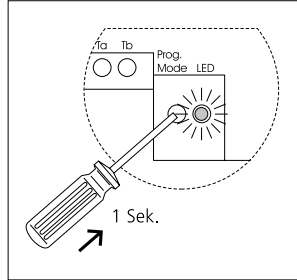

**2** Switch the BSE 650-... to the programming mode. To do this, briefly press the programming mode button with a small screwdriver. The LED flashes slowly.

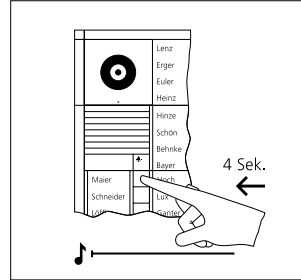

**3** At the door station, press the call button you wish to be assigned to the BSE 650-... An assignment to one or more bus telephones must exist.

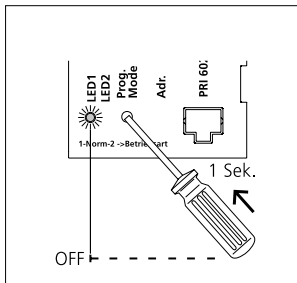

**4** Program additional users using the same procedure or quit the programming mode.

## Door call to BSE 650-...

Potential-free switching contact which is closed on placement of a door call. Due to the structure design, the BSE 650-... can be mounted in a 70 junction box.

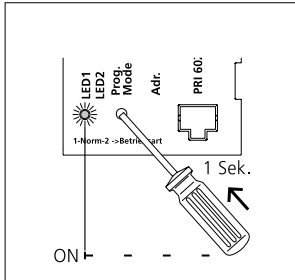

**1** Switch on the programming mode. At the BNG/BVNG 650-..., press the programming mode button briefly. The LED 1 flashes in a 2-second rhythm to indicate that the programming mode is active.

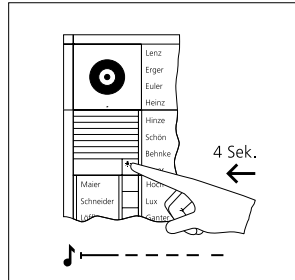

**2** At the door station, hold down the light/programming button for 4 seconds. A protracted acknowledgement tone is then audible which is repeated every 5 seconds as long as the programming mode remains active.

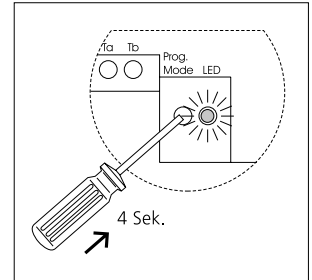

**3** Switch the BSE 650-... to the programming mode. To do this, briefly press the programming mode button with a small screwdriver. The LED flashes slowly.

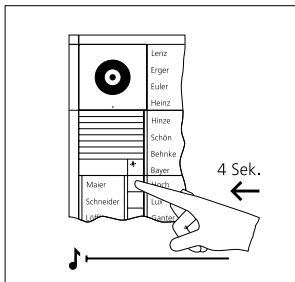

**4** At the door station, press the call button you wish to be assigned to the BSE 650-...

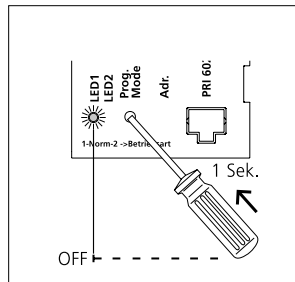

**5** Program additional users using the same procedure or quit the programming mode.

## 7.1 Programming – manual

Button of a bus telephone on the BSE 650-...

Actuation of additional functions such as switching on the staircase light or garage door OPEN/SHUT. Switching time with manual programming 1 second.

In the BVPC 850-..., programming is performed at the PC using bus programming software BPS 650-...

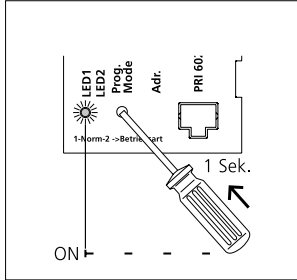

**1** Switch on the programming mode. At the BNG/BVNG 650-..., press the programming mode button briefly. The LED 1 flashes in a 2-second rhythm to indicate that the programming mode is active.

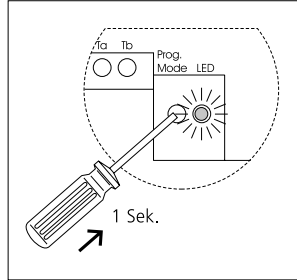

**2** Switch the BSE 650-... to the programming mode. To do this, briefly press the programming mode button with a small screwdriver. The LED flashes slowly.

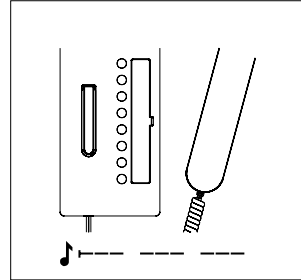

**3** Lift the receiver at the bus telephone which you wish to program.

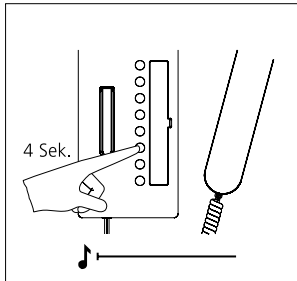

**4** Press the button you wish to program and hold down for 4 seconds. A protracted acknowledgement tone is audible in the receiver. The switching contact of the BSE 650-... is closed for 1 second.

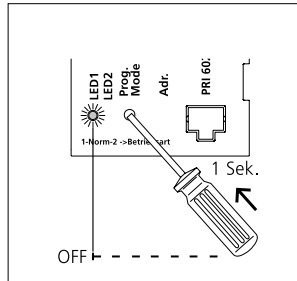

**5** Program additional users using the same procedure or quit the programming mode.

## Bus secondary signal unit BNS 750-...

Signal device to additionally indicate the door call and/or storey call in another room.

Where there are several doors, the same programming sequence must

be used every time.

For activating an indoor device (switching to the programming mode).

For more information, see page 89

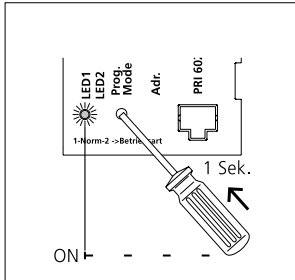

**1** Switch on the programming mode. At the BNG/BVNG 650-..., press the programming mode button briefly. The LED 1 flashes in a 2-second rhythm to indicate that the programming mode is active.

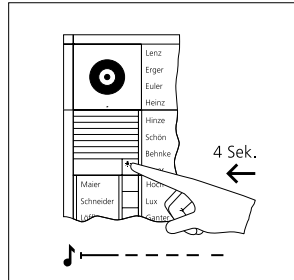

**2** At the door station, hold down the light/programming button for 4 seconds. A protracted acknowledgement tone is then audible which is repeated every 5 seconds as long as the programming mode remains active.

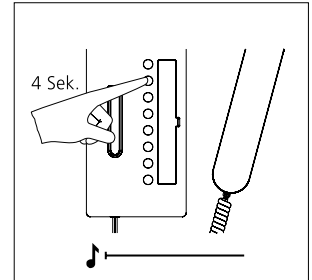

**3** Lift the receiver at the bus telephone which you wish to program. Hold down the light button for 4 seconds. A protracted acknowledgement tone sounds in the receiver, the muting button flashes. A speech connection exists to the door station. The bus telephone is now in the programming mode. Leave the receiver off the hook.

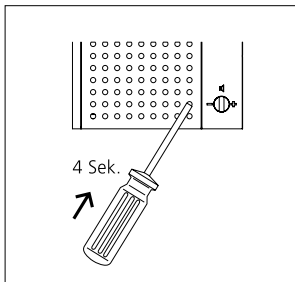

**4** Hold down the programming button of the bus secondary signal unit through the opening in the louvre for 4 seconds. A brief acknowledgement tone is audible.

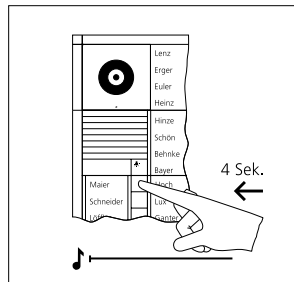

**5** At the door station, hold down the required call button for 4 seconds until a protracted tone sounds at the door loudspeaker. Both users are programmed to this call button.

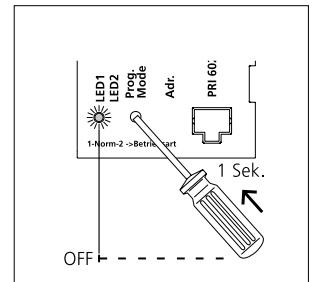

**6** Replace the receiver. Continue to program more bus telephones or quit the programming mode.

## 7.1 Programming – manual

Call via DRM 612-...

Bus telephones are called from the door station via the display call module DRM 612-...

The names in the display call module DRM 612-... must be assigned already prior to the start of user programming. Names are entered at a PC using the programming

software PRS 602-... For connection of the PC to the DRM 612-... the programming interface PRI 602-... is required.

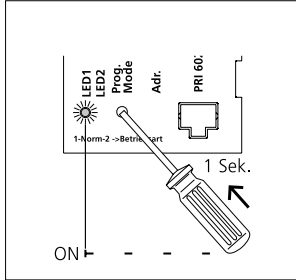

**1** Switch on the programming mode. At the BNG/BVNG 650-..., press the programming mode button briefly. The LED 1 flashes in a 2-second rhythm to indicate that the programming mode is active.

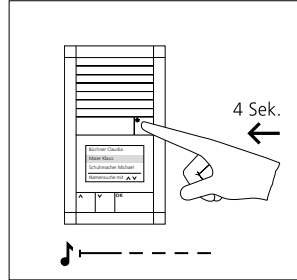

**2** At the door station, hold down the light/programming button for 4 seconds. A protracted acknowledgement tone is then audible which is repeated every 5 seconds as long as the programming mode remains active.

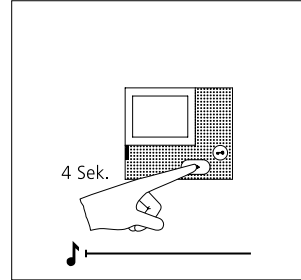

**3** Hold down the speech button for 4 seconds. A protracted acknowledgement tone sounds as confirmation and the muting LED begins to flash. The bus indoor device establishes the speech connection to the door station. The bus indoor device is now in the programming mode.

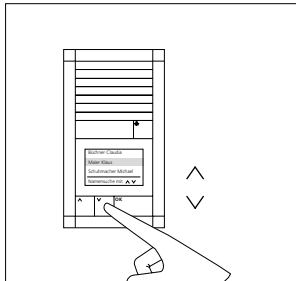

**4** At the door station, select the required name using the two arrow buttons.

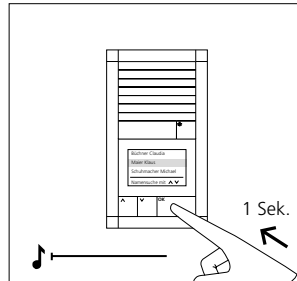

**5** When the selected name is shown on the display, press the OK button on the DRM 612-..., a protracted tone can be heard at the door loudspeaker. The selected name is now assigned to the bus indoor device. The speech connection is interrupted. If the name was already programmed, the OK button must be pressed twice.

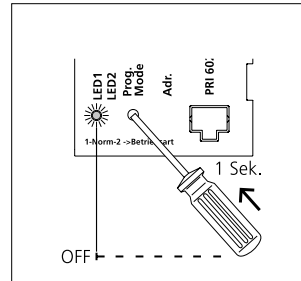

**6** Program additional users using the same procedure or quit the programming mode.



## Call via COM 611-...

Bus telephones are called by the door station via the COM 611-... code lock module.

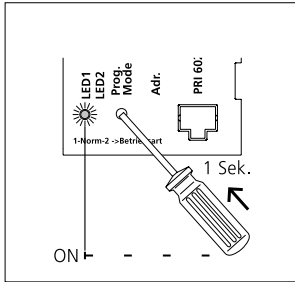

**1** Switch on the programming mode. At the BNG/BVNG 650-..., press the programming mode button briefly. The LED 1 flashes in a 2-second rhythm to indicate that the programming mode is active.

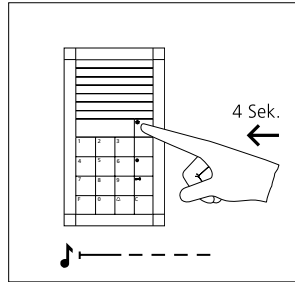

**2** At the door station, hold down the light/programming button for 4 seconds. A protracted acknowledgement tone is then audible which is repeated every 5 seconds as long as the programming mode remains active.

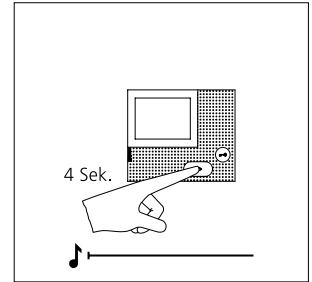

**3** Hold down the speech button for 4 seconds. A protracted acknowledgement tone sounds as confirmation and the muting LED begins to flash. The bus indoor device establishes the speech connection to the door station. The bus indoor device is now in the programming mode.

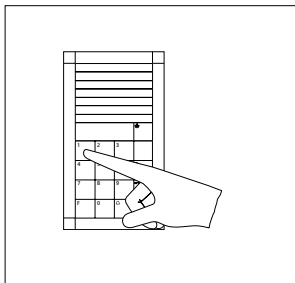

**4** Enter the required 1-8 digit (1-9999999) call number at the door station.

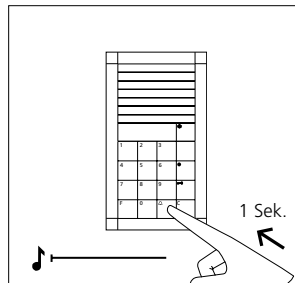

**5** Once the required digit has been entered, hold down the button with the bell symbol on the COM 611-..., a protracted tone can be heard at the door loudspeaker. The selected call number is now assigned to the bus indoor device. The speech connection is interrupted.

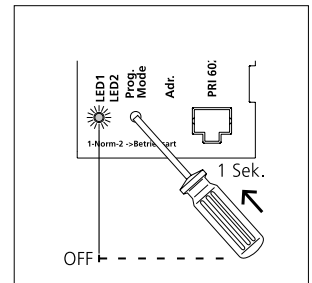

**6** Program additional users using the same procedure or quit the programming mode.

At the Jung indoor station, a different ringtone can optionally be selected for the door call.

The volume of the door call can be changed at the Jung indoor device.

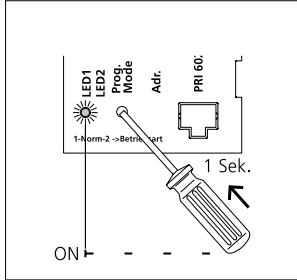

**1** Switch on the programming mode. At the BNG/BVNG 650-..., press the programming mode button briefly. The LED 1 flashes in a 2-second rhythm to indicate that the programming mode is active.

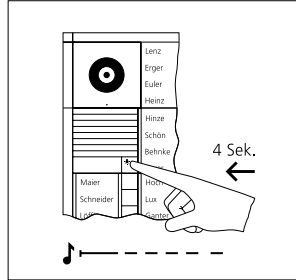

**2** At the door station, hold down the light/programming button for 4 seconds. A protracted acknowledgement tone is then audible which is repeated every 5 seconds as long as the programming mode remains active.

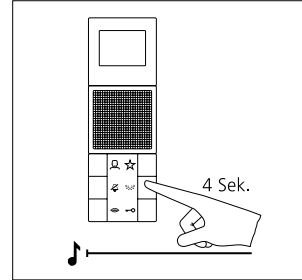

**3** Hold down the light button for 4 seconds. A protracted acknowledgement tone sounds as confirmation and the muting button begins to flash. The video indoor station establishes the speech connection to the door station. The video indoor station is now in the programming mode.

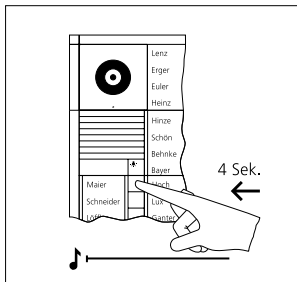

**4** On the door station, press and hold the desired call button for 4 seconds until a sustained tone can be heard from the door loudspeaker. The call button is now assigned to the bus indoor station.

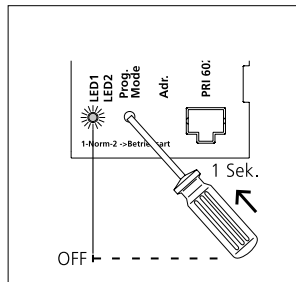

**5** The call button is now firmly assigned to the video indoor station. Program additional users using the same procedure or quit the programming mode.

## Parallel door call to Jung indoor station

A door call has to be signalled at several Jung indoor stations simultaneously.

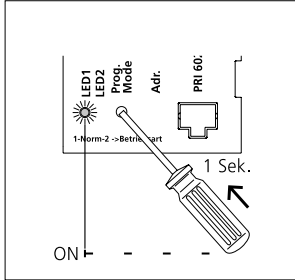

**1** Switch on the programming mode. At the BNG/BVNG 650-..., press the programming mode button briefly. The LED 1 flashes in a 2-second rhythm to indicate that the programming mode is active.

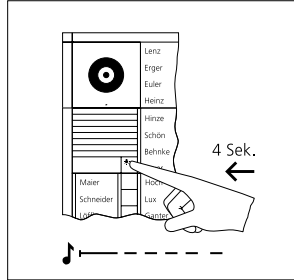

**2** At the door station, hold down the light/programming button for 4 seconds. A protracted acknowledgement tone is then audible which is repeated every 5 seconds as long as the programming mode remains active.

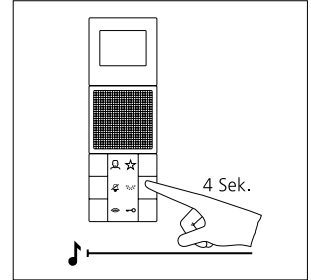

**3 Video indoor station 1:** Hold down the light button for 4 seconds. A protracted acknowledgement tone sounds as confirmation and the muting button begins to flash. The video indoor station establishes the speech connection to the door station. The video indoor station is now in the programming mode.

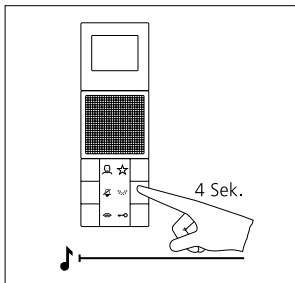

**4 Video indoor station 2:** Hold down the light button for 4 seconds. A protracted acknowledgement tone sounds as confirmation and the muting button begins to flash. Perform the same procedure in all other video indoor stations.

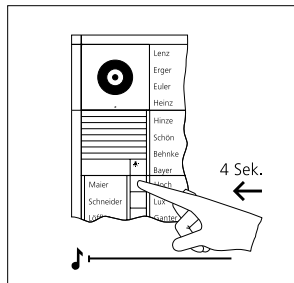

**5** On the door station, press and hold the desired call button for 4 seconds until a sustained tone can be heard from the door loudspeaker. The call button is now assigned to the bus indoor device.

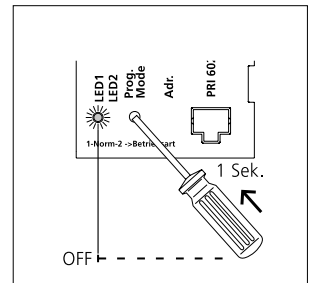

**6** The call button is now firmly assigned to all the video indoor stations.

Program additional users using the same procedure or quit the programming mode.

## 7.1 Programming – manual

### Internal call between Jung indoor stations

You wish a Jung indoor station to be able to call and communicate with another Jung indoor station in the system.

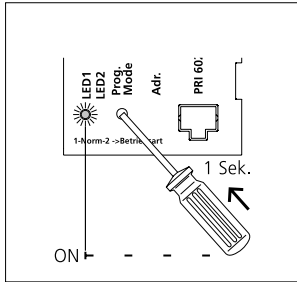

**1** Switch on the programming mode. At the BNG/BVNG 650-..., press the programming mode button briefly. The LED 1 flashes in a 2-second rhythm to indicate that the programming mode is active.

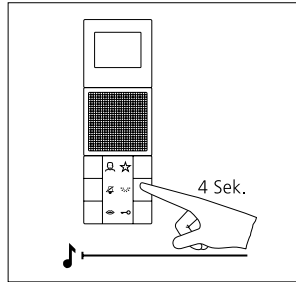

**2 Video indoor station 1:** Hold down the light button for 4 seconds. A protracted acknowledgement tone sounds as confirmation and the muting button begins to flash.

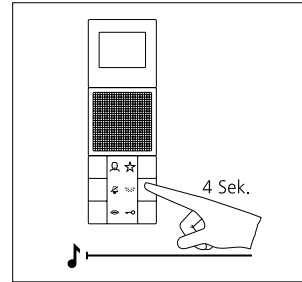

**3 Video indoor station 2:** Hold down the light button for 4 seconds. A protracted acknowledgement tone sounds as confirmation and the muting button begins to flash.

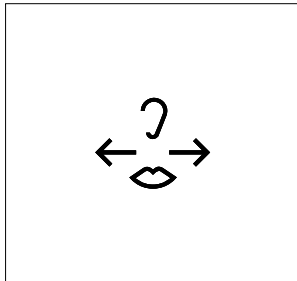

**4** A speech connection now exists between the two video indoor stations.

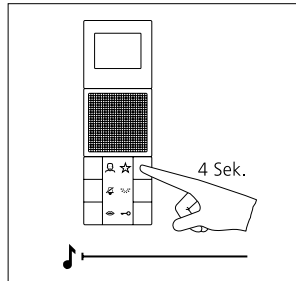

**5 Video indoor station 1:** Hold down the internal call button you wish to use to call the second device for 4 seconds. A protracted tone is audible.

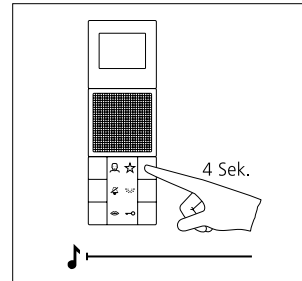

**6 Video indoor station 2:** Hold down the internal call button you wish to use to call the first device for 4 seconds. A protracted tone is audible. The buttons are now programmed at both devices.

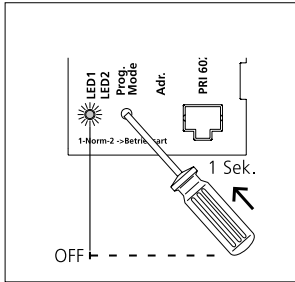

**7** Switch off the programming mode at the BNG/BVNG 650-...

## 7.2 Programming – Plug+Play

### Basics

Plug+Play programming offers the opportunity for those without programming experience to commission an In-Home bus system. The entire installation of all users must have been completed. The **housings of the bus telephones must not yet have been closed**. The Plug+Play mode must be activated at the bus line rectifier. By being connected to the bus door loudspeaker, the call buttons at the bus call button module are assigned a consecutive number. The bus telephones are subsequently locked onto the base plates in this sequence.

#### Conditions for Plug+Play:

- Plug+play-programming is only possible with new bus indoor devices, new bus door loudspeaker BTLM 650-04/BTLE 050-03, bus call button modules BTM 650-01, -02, -03, -04, BRMA 050-01 and bus line rectifiers BNG/BVNG 650-...
- Plug+play-programming only works for bus indoor devices within any one line.
- Several door stations within a line are programmed simultaneously with the same assignment, e.g. two door stations with 4 call buttons have the same assignment. Where there is more than one bus call button module, numbering of the call buttons takes place in the same sequence in which the modules are connected to each other via the IN/OUT connections.

#### Conditions for Plug+Play:

- Install the system in accordance with the wiring diagram.
- Connect the base plates of the bus telephones, **do not yet close the housings**.
- Connect the Jung modules to each other using the supplied connecting cables. The terminal block must **not yet** be plugged in.
- At the door station, document the assignment of call buttons or if possible inscribe straight away.
- Set the bus line rectifier to the Plug+Play mode by holding down the programming mode button for 5 seconds. LED 1 must stay on continuously.
- Mount the bus telephones on the base plates in the same sequence as the assignment of call buttons. (receiver down)
- Where a Jung indoor station is used, plug in the terminal block.
- The storey call is audible briefly after appr. 7 seconds as an acknowledgement and the LED under the call silencing button starts to flash. The next bus telephone can then be closed.
- After all the telephones have been closed, at the bus line rectifier press the programming mode button. The programming mode is switched off, the programming of the system is complete.

#### Reset Plug+Play:

- All already connected bus telephones must be locked into position on the base plates.
- Switch off the supply voltage to the bus line rectifier.
  - Disconnect terminals Ta and Tb
  - Change the address of the bus line rectifier, e.g. from address 1 to address 2
  - Hold down the Prog. mode button for around 3 seconds and switch on the supply voltage of the bus line rectifier. After around 3 seconds release the button, wait until LED 1 indicates the standard operating mode again.
  - Reconnect terminals Ta and Tb and wait until the system has finished running up.
  - Pick up all bus telephones from the base plates again.
  - Return the address switch to its original status, e.g. change from 2 to 1, and wait until the system has finished running up. Check whether all the bus telephones have been picked up again. Plug+Play programming can begin again.

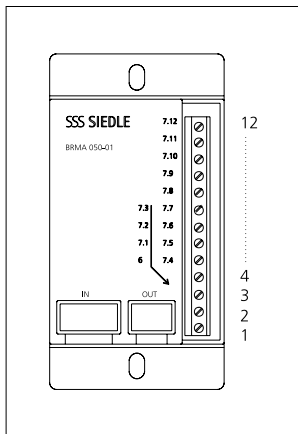

### Bus custom-fit door loudspeaker

The sequence of terminals on the bus call button matrix corresponds to the sequence of bus telephones.

Terminal 7.1 = Bus telephone 1  
etc.

Terminal 7.12 = Bus telephone 12

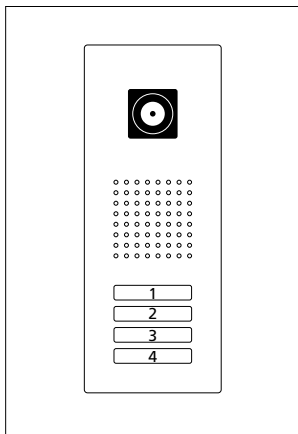

### Siedle Classic

The sequence of terminals on the bus call button matrix corresponds to the sequence of bus telephones.

The uppermost button is button 1, remaining buttons follow in consecutive sequence.

Terminal 7.1 = Bus telephone 1  
etc.

Terminal 7.4 = Bus telephone 4

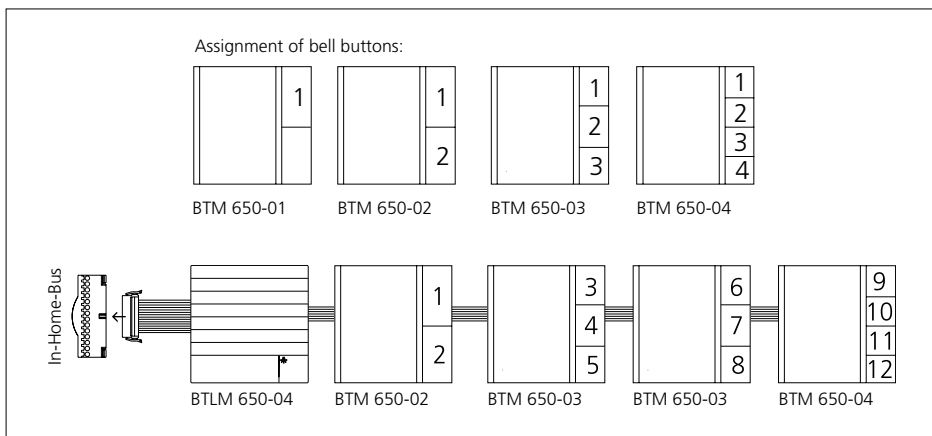

## 7.2 Programming – Plug+Play

Example of a 4-family home

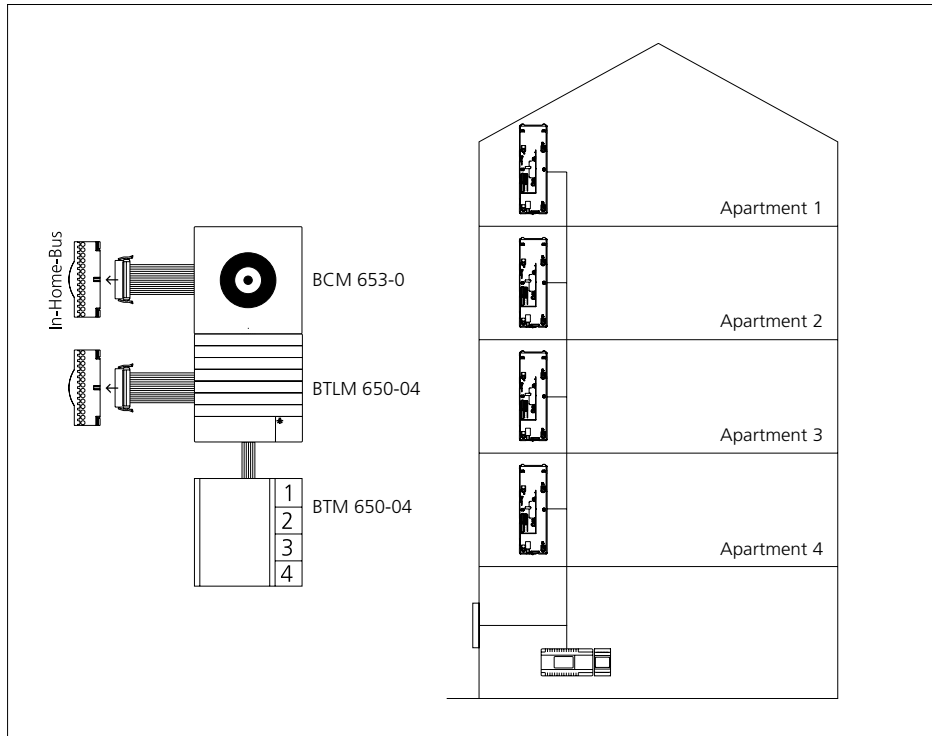

### Restrictions

- Bus telephones which are already assigned to a door loudspeaker in the same line are not reprogrammed.
- Bus telephones which are already programmed in a different line are reassigned to a bell button.
- Call buttons of the BTLM/BTLE are disabled during Plug+Play programming, no inputs can be made.
- Plug+Play programming can be continued in an existing system. The next free call button is assigned.
- Bus telephones which you wish to ring in parallel or devices for switching and control functions must be programmed manually or via the PC and BPS 650-...

This step can also be performed at a later stage.

### Possible errors

- If unsuitable devices log in during Plug+Play programming (old bus telephone models such as BTS/ BTC 750-... or BSM etc.) the configuration is aborted and an error signal sent to fault LED 2 at the BNG/BVNG 650-...
- If door bell buttons have been assigned to the wrong bus telephones during Plug+Play programming, the BNG/BVNG 650-... must be restored to as-delivered status and Plug+Play programming repeated. Alternatively it is possible to overwrite the bus telephones using manual programming.



## Procedure – Example

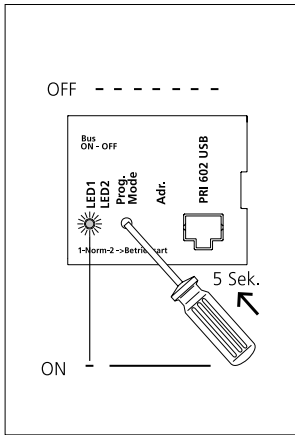

**1** Activate the Plug+Play-mode at the BNG/BVNG 650-..., hold down the programming mode button for 5 seconds. LED 1 lights up permanently.

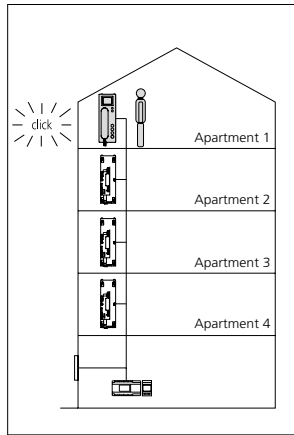

**2** Set up the bus telephone in apartment 1 with the receiver in place, the storey call sounds as an acknowledgement tone and the LED of the muting button flashes. Bus telephone 1 is assigned to button 1.

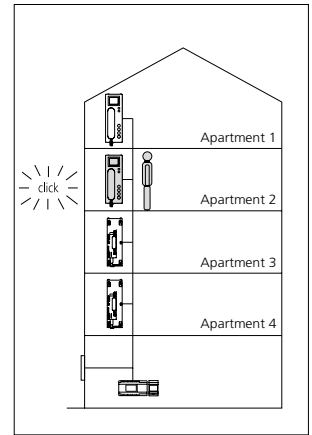

**3** Set up the bus telephone in apartment 2 with the receiver in place, the storey call sounds as an acknowledgement tone and the LED of the muting button flashes.

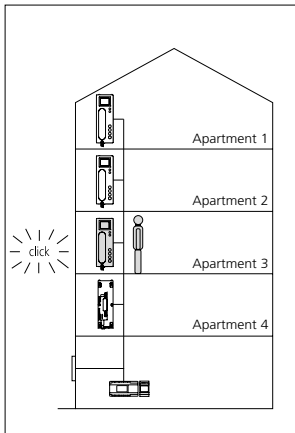

**4** Set up the bus telephone in apartment 3 with the receiver in place, the storey call sounds as an acknowledgement tone and the LED of the muting button flashes.

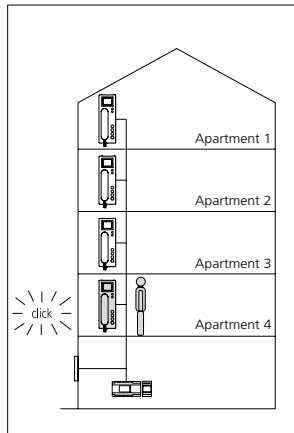

**5** Set up the bus telephone in apartment 4 with the receiver in place, the storey call sounds as an acknowledgement tone and the LED of the muting button flashes.

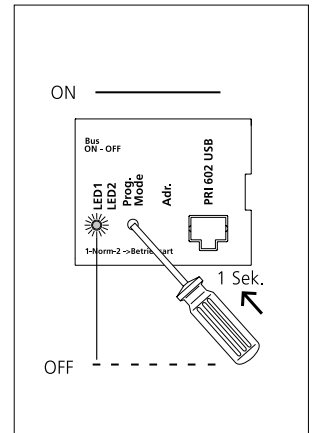

**6** Switch off the Plug+Play-mode at the BNG/BVNG 650-... by briefly pressing the programming mode key. The LED 1 at the BNG/BVNG 650-... now flashes again to indicate normal operation. All LEDs at the bus telephones are off, the system is ready for operation.

## 7.3 Programming – with PC

### BPS 650-... and PRI 602-... USB

Using bus programming software BPS 650-... the entire function of an In-Home system can be programmed using a Windows PC. For connection of the PC to the In-Home installation, the programming interface PRI 602-... USB and the bus power supply accessory ZBVG 650-... are required. The ZBVG 650-... is plugged once within a system and once in a BNG/BVNG 650-... The PRI 602-... USB can be permanently installed in a system or can be plugged in via an 8-pin Western junction box. Current updates for the BPS 650-... software are available in the download area under [www.siedle.com](http://www.siedle.com). For more information on how to commission the system using the Bus programming software BPS 650-... refer to the software online help.

The user interface of the deluxe bus video panel is transmitted to the BVPC 850-... using the supplied SD card. See operating instructions for the BVPC 850-...

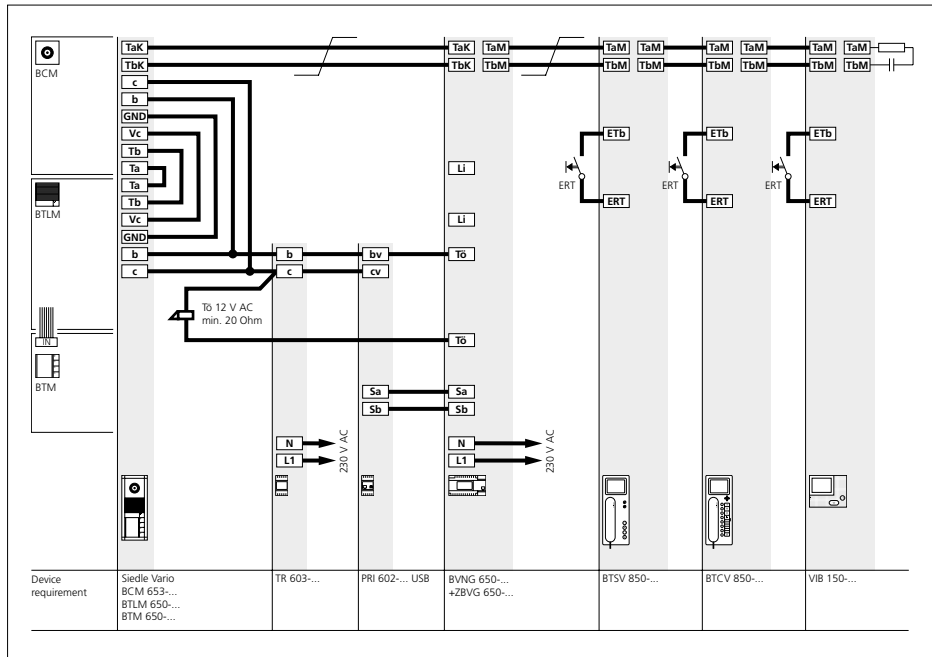
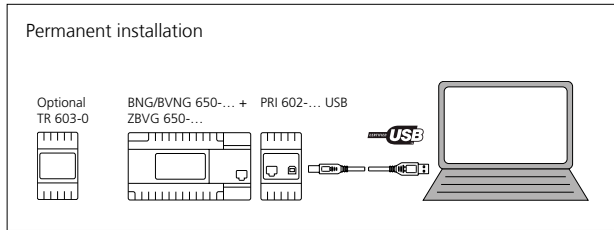
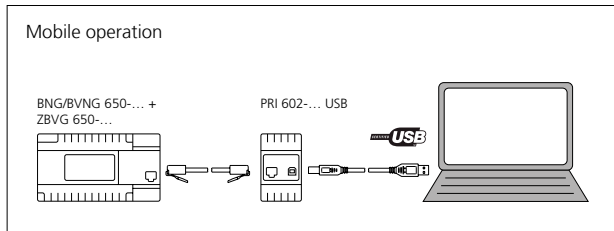

## 8 Supplementary functions

### Switching and control functions

#### Bus switching unit

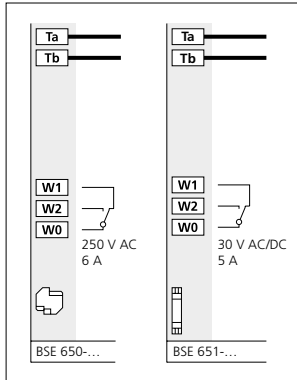

#### Application

- 1 Changeover contact, e.g. for
  - Switching the outside light
  - Opening the garage door
  - Staircase lighting
  - Mounting possible in a 70 junction box
- Switching functions possible with feedback to deluxe bus indoor devices

#### Function

- Switch ON/OFF
- Timer between 0.4 seconds and 19 minutes 59 seconds (as-delivered status)
- Toggle function (status change with each button actuation)
- Secondary signal contact for additional bell
- Supply via In-Home bus

#### Actuation via

- Control buttons of the bus telephones
- Light or call button of a door station
- Bus input module BEM 650-...

#### Programming

Basic switch/timer function by means of manual programming, other functions only using BPS 650-...

#### Bus switching module

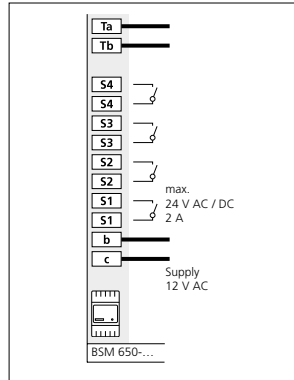

#### Application

- 4 working contacts, e.g. for
  - Switching the outside light
  - Opening the garage door
  - Staircase lighting etc.
  - Mounting on top hat rail

#### Function

- Timer between 0.4 and 12 seconds, switching of an additional door release or gate
- Secondary signal contact for additional bell

#### Actuation via

- Control buttons of the bus telephones
- Light or call button of a door station
- Bus input module BEM 650-...

#### Programming

Manual programming or using BPS 650-...

#### Power supply

Supply with 12 V AC from a BNG 650-... or transformer TR 603-...

#### Bus input module

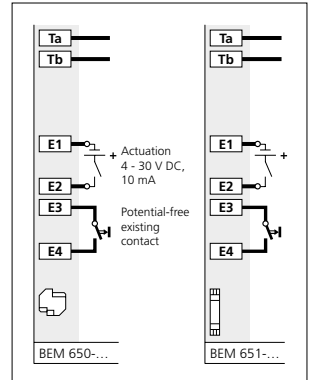

#### Application

- Optical feedback of switching statuses, e.g.
  - Open garage door,
  - Error message heating
- To actuate the BSE/BSM 650-...
- Mounting possible in a 70 junction box

#### Function

- Initiation of switching/control functions within the Siedle In-Home bus
- Signal input within the Siedle In-Home bus
- Supply via In-Home bus.

#### Actuation via

Potential-free button or Direct voltage 4-30 V DC

#### Programming

Function can only be programmed using BPS 650-... software

# 8 Supplementary functions

## Switching and control functions

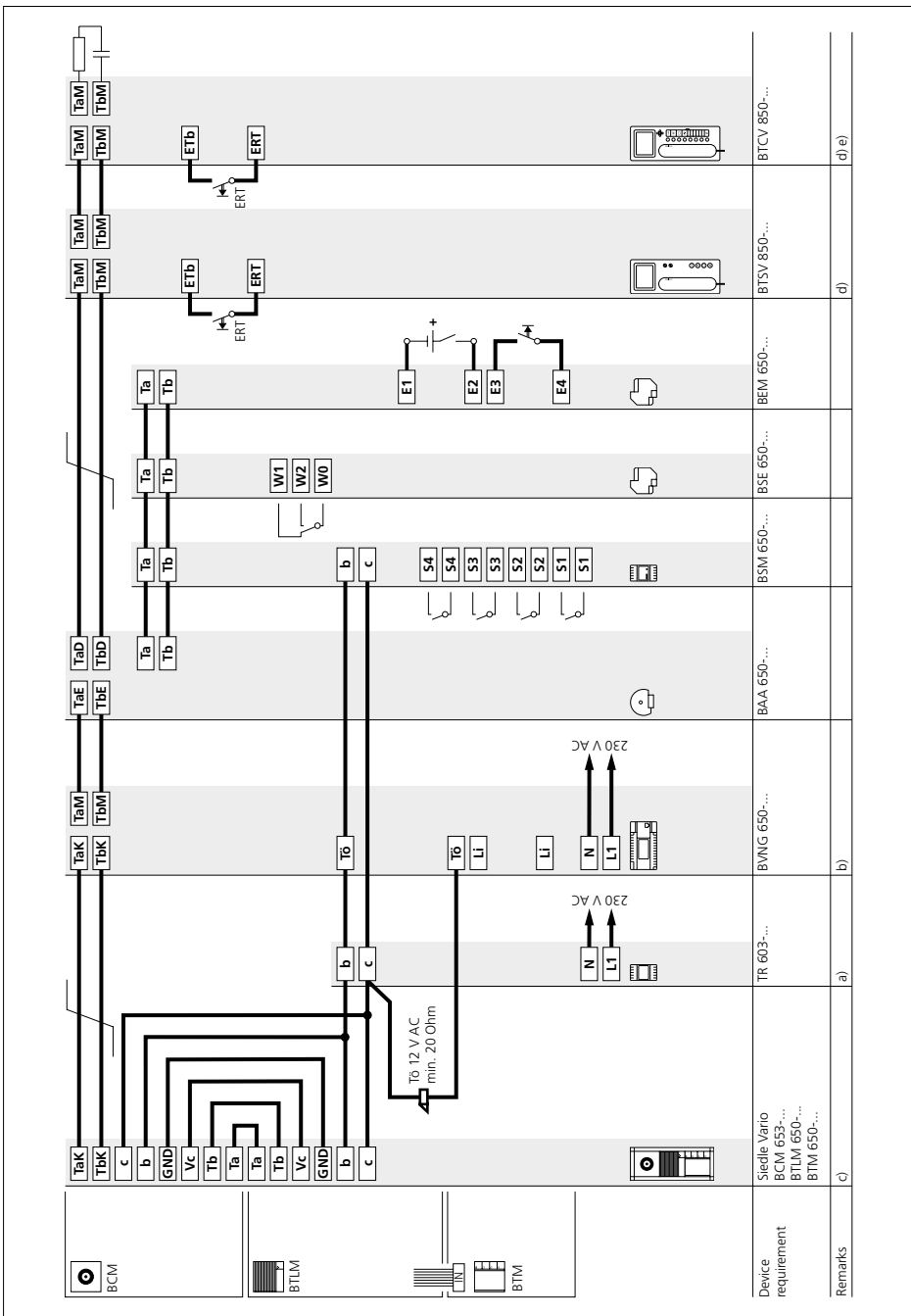

Device requirement  
 BCM 653...  
 BTLM 650...  
 BTM 650...

Remarks  
 c)

BVCV 850...

d) e)

BTSV 850...

d)

BEM 650...

BSE 650...

BSM 650...

BAA 650...

BVING 650...

b)

TR 603...

a)

## Switching and control functions

### Functional

Calling, speech and video functions between door station and the connected bus indoor devices with colour display.

Audio and video privacy of existing calls from other bus indoor devices is assured. Door release button for the door release function, light button for the light switching function.

Pressing the monitor button will show the camera picture from the door station which placed the last door call. This function is only possible if no call exists.

Connection of a storey call button (ERT) for calling from an apartment door. Ringtones can be selected for calls from the front door, apartment door or internal calls.

Connection of other bus indoor devices with colour display when looping through from one device to the next.

## Switching and control functions

Via bus audio decoupler BAA 650-... the devices for switching and control functions are connected to the In-Home-Bus: Video. Downstream from a BAA 650-... it is possible to operate up to 31 users. Pay attention to the total number of admissible users in the line. There are two ways of programming switching and control functions.

- Manual programming
- PC programming using bus programming software BPS 650-... from V2.50.

Setting of all functions e.g. changing times, feedback signals etc.

## Remarks

**a)** The TR 603-... (12 V AC, 1.3 A) can supply the door release, camera heating and max. 30 bus call button modules.

Where more bus call button modules are used, an additional TR 603-... is required for the door release.

**b)** Door release/light contact load in the bus video line rectifier BVNG 650-... max. 15 V AC, 30 V DC, 2 A.

**c)** Door release 12 V AC, use at least 20 Ohm (e.g. TÖ 615-...).

For more information, see page 126

**d)** Conductor length bus indoor device – storey call button ERT max. 50 m.

**e)** When using the video memory module, the bus telephone BTCV 850-... must be supplied by an additional direct voltage (20–30 V DC, 350 mA).

For more information, see page 128

## 8 Supplementary functions

### Door release actuation

In deviation from the standard plans, the door release can be actuated in various ways. The bus line rectifier BNG/BVNG 650-... has a DR contact which is closed every time the door release button is actuated. At the door loudspeakers BTLM 650-... and BTLE 050-... there is also a door release contact which is only closed when the bell has previously been rung at the relevant door loudspeaker. If several door loudspeakers

are operated within a system, both contacts are required to open the door station. In general, high-resistance door releases must be used in order to guarantee the greatest possible degree of operating reliability/ the greatest possible range. Use a Siedle door release or a 12 V AC door release with an impedance of at least 20 Ohm.

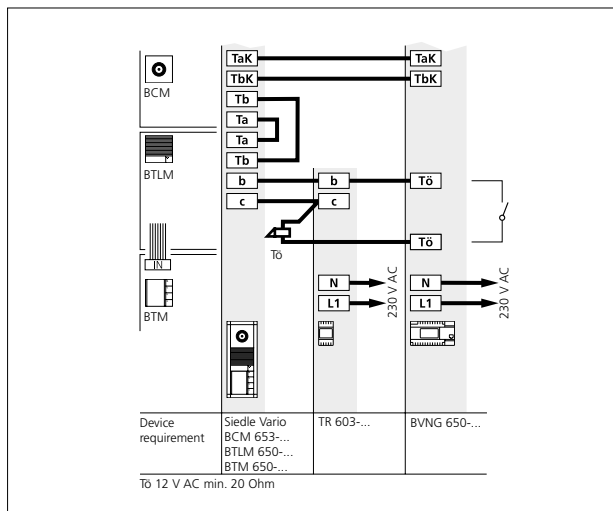

#### Application

Externally positioned door stations  
The door release contact (DR contact) at the bus line rectifier switches every time the door release button is pressed.

#### Benefits

- Tamper-proof, no access from the outside
- Only 4 cores to the door station

#### Drawbacks

- The door release must be routed to the distributor
- Installation only possible with 1 door station in the line
- With several door stations, this installation is not possible

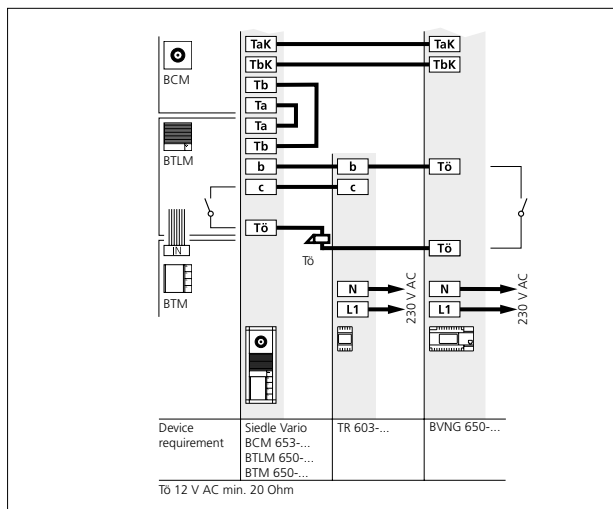

#### Application

Externally positioned door stations  
The bus line rectifier DR contact and the DR contact in the door loudspeaker are used. Both contacts switch every time the door release button is pressed.

#### Benefits

- Tamper-proof, as no access from the outside
- Tamper-proof door release even with several door stations in a system
- Installation principle possible even with several door stations

#### Drawbacks

- The door release must be routed to the distributor and to the door loudspeaker
- 5 cores required to the door station

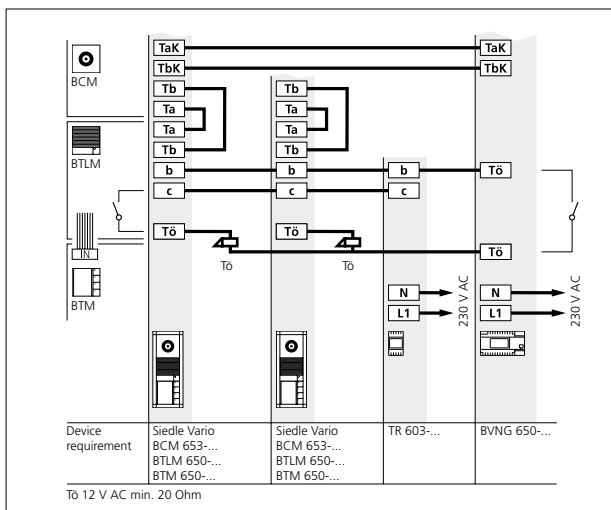

### Application

Systems with more than one door station with door release. The Tö contact (door release contact) in the bus line rectifier and the door release contact in the door loudspeaker are used. The contact in the BNG/BVNG 650-... switches the door release button every time it is pressed, the contact in the door loudspeaker only at the door from which the last door call was placed.

### Benefits

- Tamper-proof, as no access from the outside

### Drawbacks

- The door release must be routed to the distributor
- 5 cores are required to each door station

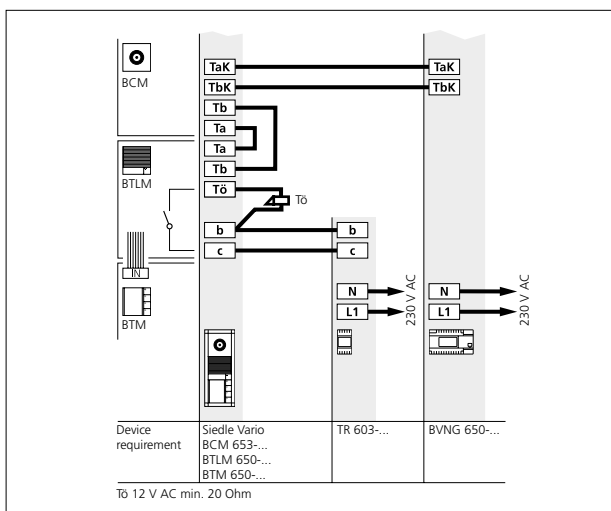

### Application

Garden gate or areas without security relevance. The DR contact in the door loudspeaker switches every time the door release button is pressed.

### Benefits

- Only 4 cores to the door station, the door release is connected directly in the door station
- Several door stations possible without additional installation

### Drawbacks

- Not tamper-proof, as access possible from outside

## 8 Supplementary functions

### Parallel door call, supplementary power supply, video memory

#### Parallel door call

Only possible within a line.

At the In-Home bus: Video can ring 1 bus telephone with colour monitor without additional supply to a bell button. With an additional direct voltage supply to bus telephones VIB 150-.../BTSV/BTCV 850-... up to 8 bus telephones with colour monitor can be called simultaneously via a bell button. When providing the additional supply, note the current

consumption of the bus telephones as well as the admissible conductor length. The more devices are supplied, the shorter the admissible conductor length becomes.

#### Video memory

When using the video memory in the BTCV 850-... a supply must always be provided via terminals +M/-M.

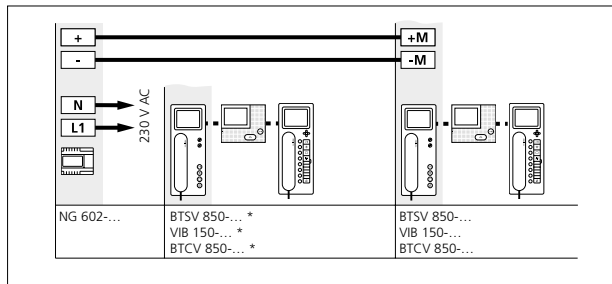

A maximum of 1 VIB 150-.../BTSV/BTCV 850-... unit can be supplied by a NG 602-... line rectifier. If several bus telephones have to be simultaneously rung using one bell button, each VIB 150-.../BTSV/BTCV 850-... must have its own NG 602-...

#### Power supply with NG 602-...

#### Max. conductor length/Distance of the supplementary supply

BTSV 850-.../VIB 150-... Current consumption 300 mA	1 device 100 m*	2 device 70 m	3-8 device Further additional power supply
BTCV 850-... Current consumption 350 mA	1 device 100 m**	2 device 70 m	3-8 device Further additional power supply

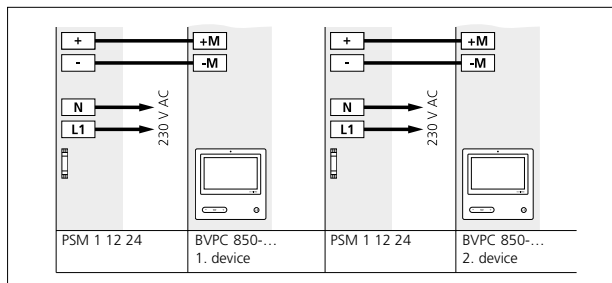

A maximum of 1 BVPC 850-... can be supplied with a PSM 1 12 24 line rectifier. In systems with bus video panel, a maximum of 2 PSM 1 12 24 may be used.

#### Power supply with PSM 1 12 24

#### Max. conductor length/Distance of the supplementary supply

BVPC 850-...	1 device 200 m	2 device Further additional power supply
--------------	-------------------	---



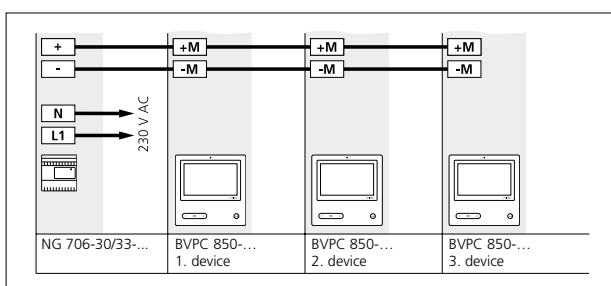
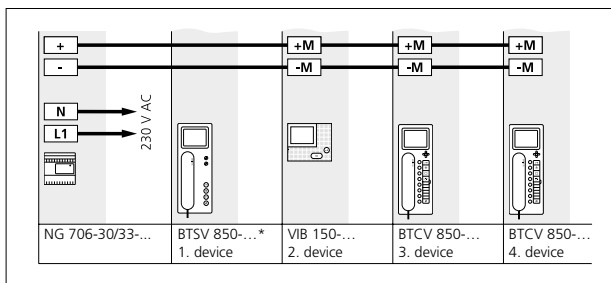

A maximum of 3 VIB 150-.../BTSV/ BTCV/BVPC 850-... units can be supplied by a NG 706-30/33-... line rectifier. The specified ranges only apply to the external power supply to the devices, not to the ranges of the In-Home bus. Ranges applicable for J-Y(St)Y or YR installation cable with 0.8 mm core diameter! Only bus indoor devices which are located in the same line can be supplied by one line rectifier.

#### Power supply with NG 706-30/33-... Max. conductor length/Distance of the supplementary supply

BTSV 850-.../VIB 150-..., 300 mA	1 device	2 device	3 device	4 device
Operating mode NORM	100 m*	100 m	100 m	100 m
Operating mode NORM, cable J-Y(St)Y	150 m*	150 m	140 m	100 m
Operating mode increased range	200 m***	140 m	100 m	not possible
BTCV 850-..., 350 mA	1 device	2 device	3 device	4 device
Operating mode NORM	100 m*	100 m	100 m	100 m
Operating mode NORM, cable J-Y(St)Y	150 m*	150 m	140 m	100 m
Operating mode increased range	200 m***	140 m	100 m	not possible
BVPC 850-...	1 device	2 device	3 device	4-8 device
	200 m	120 m	70 m	Further additional power supply

\* Power supply directly from the In-Home bus, then no video memory function at the BTCV 850-...

\*\* In case of parallel switching with DoorCom DCA 650-..., an additional power supply is required from the first bus telephone.

\*\*\* In the increased range operating mode, each bus telephone must be additionally supplied by its own line rectifier.

## 8 Supplementary functions

Parallel door call, supplementary power supply, video memory

### Power supply to 8 bus tele-phones

In the example, 8 bus telephones have to be programmed to 1 call button.

Manual programming must start with the first bus telephone without power supply.

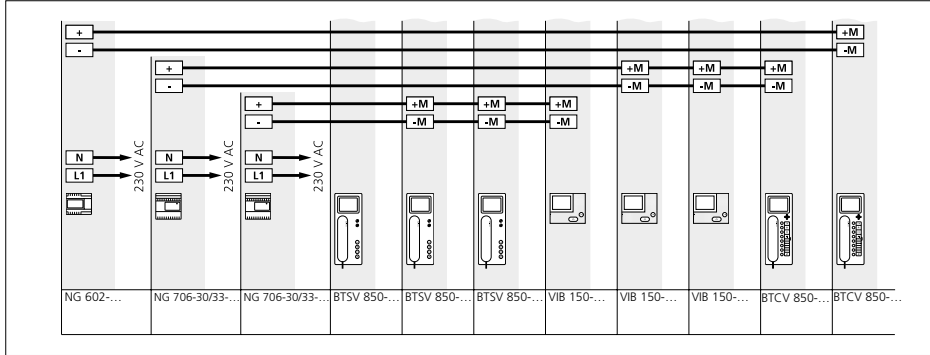

**Supply of 8 Jung video indoor stations**

A maximum of 6 SI VI ... units can be supplied by a NG 706-30/33-... line rectifier. The maximum current of the 30 V DC direct voltage from the NG 706-30/33-... is 1100 mA.

The specified ranges only apply to the external power supply to the devices, not to the ranges of the In-Home bus. Ranges applicable for J-Y(S)tY or YR installation cable with 0.8 mm core diameter! Only devices which are located in the same line can be supplied by one line rectifier.

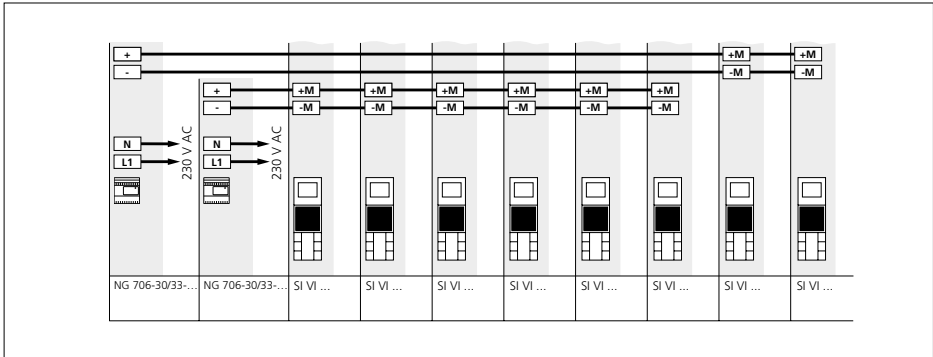

Power supply with NG 602-...	Max. conductor length/Distance of the supply	
SI VI ...	1 device	2-8 device
Current consumption 170 mA	50 m	Further additional power supply

Power supply with NG 706-30/33-...	Max. conductor length/Distance of the supply					
SI VI ...	1 device	2 device	3 device	4 device	5 device	6 device
Current consumption 170 mA	200 m	200 m	150 m	120 m	90 m	70 m

## 8 Supplementary functions

### Storey call parallel switching

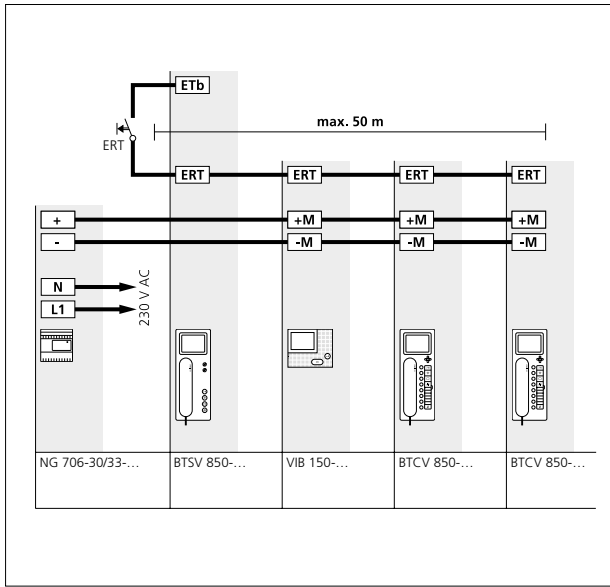

### Storey call parallel switching

The storey call button (ERT) is used to call into the apartment from an apartment door. For calls to several bus telephones, it is possible to connect the ERT terminal in parallel, e.g. office storey with 4 bus telephones and one storey call button at the storey entrance.

A maximum of 8 bus telephones can be rung in parallel using a storey call button. The terminal ETb is only connected in the first bus telephone.

**The complete range of the storey call is 50 m with a 0.8 mm core diameter**

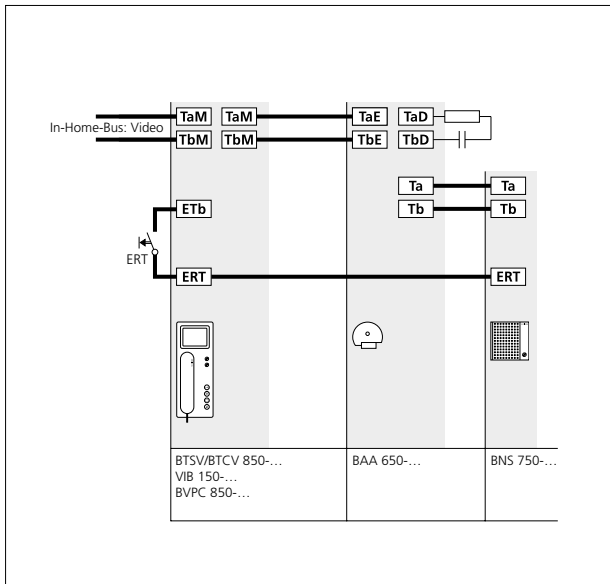

### Bus secondary signal unit

#### BNS 750-...

Additional bus secondary signal unit in parallel at a bus indoor device.

Signalling door calls and storey calls. Following the installation, the door call must be programmed at both devices.

For more information, see page 111

## Supplementary contact, radio chime, pilfer safeguard

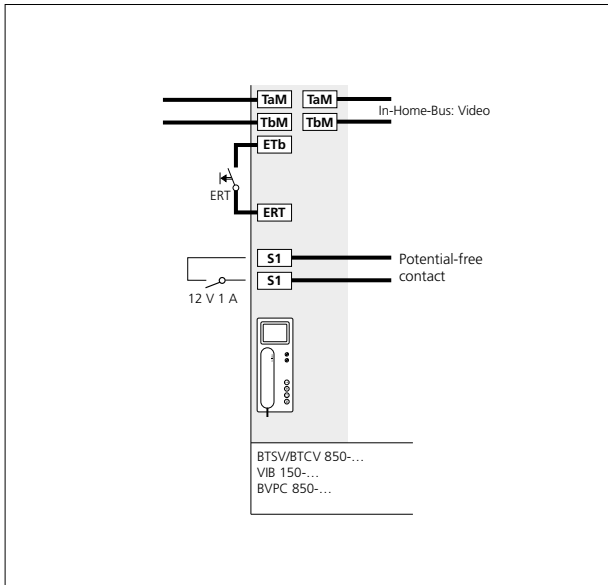

### Supplementary contact in the bus indoor device

The bus indoor devices provide an additional contact at terminals S1/S1.

Actuation of an additional signalling device such as a radio chime or optical display of the door call. If the contact is required in the sub-distributor, the door call can be programmed to a contact at a BSE/BSM 650-...

As-delivered status, secondary signal unit function 1 second, can be multifunctionally reprogrammed using BPS 650-...

Using the BPS 650-... the contact can also be programmed to a button of the bus telephone, to switch it to potential-free status.

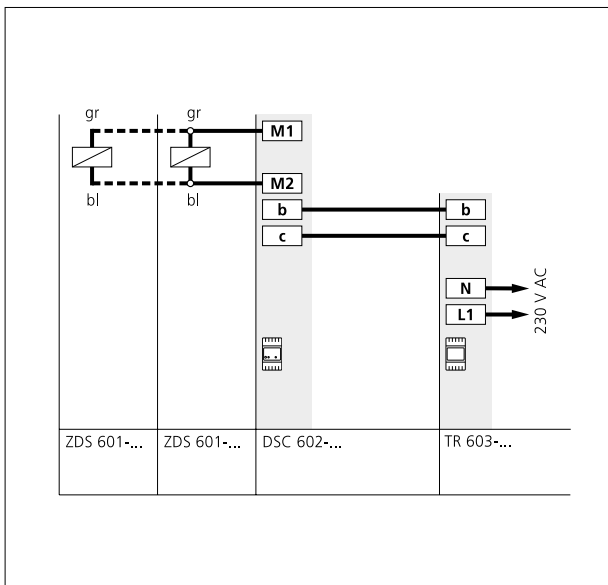

### Pilfer safeguard for Vario modules

Bistable magnet for integration in mounting frame MR 611-...

To secure valuable modules such as camera modules, code lock modules or to ensure tamper-proof operation of the door release.

A stable metal plate locks the opening mechanism and prevents modules from being removed. The magnets are opened and locked in the sub-distributor at pilfer safeguard controller DSC 602-... A maximum of 2 ZDS 601-... units can be operated at one DSC 602-...

### Range

Maximum conductor length between DSC 602-... and ZDS 601-... with 0.8 mm core diameter 100 m.

## 8 Supplementary functions

### Staircase light/Outside light

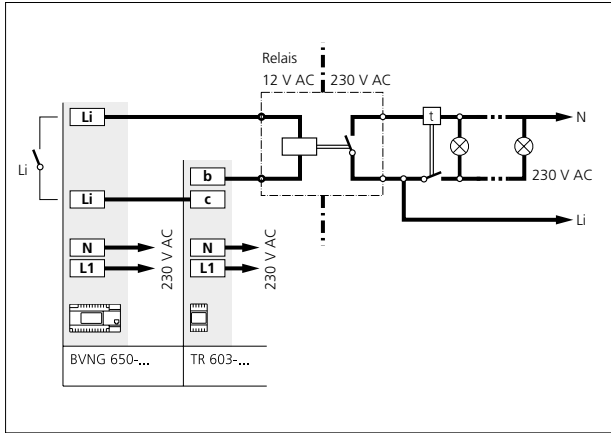

#### Light actuation

The light button in the bus indoor devices or BTLM 650... is used to actuate the light contact in the bus line rectifier BNG/BVNG 650... .

Following completion of the installation, this function is active without any further programming.

To actuate the staircase and/or outside light, according to VDE regulations a light current relay or time relay must be interconnected.

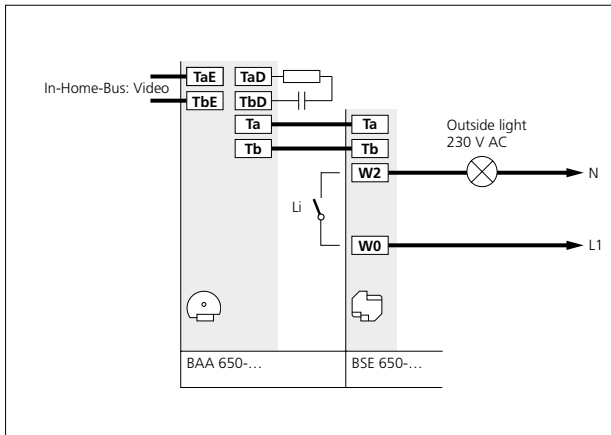

#### Light actuation

Actuation of an additional lamp via BSE 650... Max. contact load 230 V AC, 6 A.

## 9 Servicing

### Restart, exchange, operating mode

#### Restarting the system

A restart of the complete system is known as a Power-ON-Reset.

Switch off the power supply to the bus line rectifier, wait for a few seconds, switch the power back on. The system restarts, and all bus users are initialized again. The system programming is retained.

#### Delete programming

- Disconnect terminals TaK/TbK and TaM/TbM
- Change the address of the bus line rectifier, i.e. change the address from 1 to another address which is still unassigned, e.g. 2. In multiple-line systems, ensure that no address has been assigned more than once. (no waiting time required, as no device is connected at the line)
- Connect bus cores TaK/TbK and TaM/TbM

#### Restoring the as-delivered status

All programmed users in the bus line rectifier are deleted, the system must be subsequently reprogrammed.

Procedure:

- Switch off the supply voltage to the bus line rectifier.
- Disconnect terminals TaK/TbK and TaM/TbM
- Hold down the programming mode button
- Switch on the voltage and release the programming mode button after appr. 5 seconds.
- Function LED 1 flashes evenly
- Wait until the LED 1 display returns to show the normal operating status.
- Change the address of the bus line rectifier, e.g. set address 1 to 2. In multiple-line systems, ensure that no address has been assigned more than once.
- Connect bus cores TaK/TbK and TaM/TbM
- The system is reinitialized.
- Function LED 1 flashes again
- When LED 1 indicates a return to normal operational readiness, set the address of the bus line rectifier back to the original value.

- The system can now be programmed again.

#### Exchanging bus telephones in an existing system

If an already programmed bus telephone has to be exchanged, the following procedure must be adhered to:

- Switch off the bus video line rectifier power supply
- Disconnect the existing bus telephone terminals
- Connect the new bus telephone
- Switch the bus line rectifier on again and wait until the system ramp-up is completed.
- Program new users (door calls, internal calls etc.) with manual programming or using BPS 650-...

#### Exchanging the BVNG 650-... for the BVNG 650-...

The existing system programming is retained.

- Switch off the voltage
- Disconnect the existing BVNG 650-... and connect the new BVNG 650-... The same address must be set.
- Hold down the programming mode button, switch on the power.
- LED 1 flashes evenly - wait until the LED display goes out.
- When the LED 1 indicates the normal operating mode again, the previous system status has been restored

#### Exchanging the BVSG 650-... for the BVNG 650-...

The existing system programming is retained.

- Switch off the voltage
- Disconnect the existing BVSG 650-...
- Set the operating mode switch at the BVNG 650-... to 1. The address must be set the same as for the existing BVSG 650-...
- Hold down the programming mode button, switch on the power.
- LED 1 flashes evenly - wait until the LED display goes out.

- When the LED 1 indicates the normal operating mode again, the previous system status has been restored.

If an accessory card ZBVSG 650-... was plugged into the BVSG 650-..., the accessory card ZBVNG 650-... must be plugged into the new BVNG 650-...

More information on the operating mode switch is provided on the next page.

## 9 Servicing

### Operating mode switch BVNG 650-...

#### Exchanging the BVNG 650-... for the BVNG 650-...

When exchanging the BVNG 650-... in an existing system for the BVSG 650-..., the setting of the operating mode switch must be noted. The setting depends on the device types installed in the existing system.

If different device types are used together in an existing installation, the operating mode must be set to **switch setting 1**.

In the **switch setting 1** the operating current is increased to 1200 mA in order to supply the existing bus users. The performance features on the In-Home bus are not fully available in **switch setting 1**. The following functions are not supported:

- Status display of the LED for feed-back from BEM/BSE 650-...
- Doormatic
- Call forwarding
- Parallel call only possible to 2 bus telephones.

If an accessory card ZBVSG 650-... was plugged into the BVSG 650-..., the accessory card ZBVNG 650-... must be plugged into the new BVNG 650-...

It is **not possible** to **exchange a first-generation YR** bus system with the following device types:  
 BTLM 650-0/-01 with VBSM 650-...  
 BTLM 650-01 with BVSM 650-...  
 BTS/BTC 750-0 with VBE 650-...  
 VBVG 650-...

#### Operating mode switch 1-Norm-2 BVNG 650-...

Switch setting 1 "Reverse compatible"	Switch setting "Norm"
BTS 750-02 with BVE 650-0	AIB/VIB 150-...
BTC 750-02/-03 with BVE 650-0	BTS/BTC 850-...
BTLM 650-02 with BVSM 650-...	BFS/BFC 850-...
BTLM 650-02 with BVS 650-...	BFSV/BFCV 850-...
BTLE 050-02 with BVSM 650-...	BTSV/BTCV 850-...
BTLE 050-02 with BVS 650-...	BVPS/BVPC 850-...
BVI 750-...	S 850/851-...
	BCM 65x-...
	BCMC 650-...
	BVM 650-...
	BTLM 650-03/-04
	CSV/SBV/STV 850-...
	CA/CAU 850-...
	CV/CVU 850-...
	BVS 650-01 with ext. camera
	BVA 650-... with ext. camera
	SG 150/650-...
	SGM 650-...
	SI 4 A ..
	SI AI ...
	SI VI ...

In the case of devices which are not listed here, the position of the operating mode switch is not relevant, e.g. bus call button module BTM 650-...

**Switch position 2** is the **increased range** operating mode.











For more information, see page 13

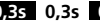
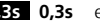



















## LED displays BVNG 650-...

The two displays LED 1 and LED 2 at the bus line rectifier indicate functions for operation and possible faults in the In-Home bus. The following table indicates the possible displays.

### Display LED 1 "Operation"

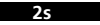
LED flashes evenly (System ramp-up)						etc.	
LED flashes short on, long off (Operation display, system is functional)	1s		1s		1s		etc.
LED flashes short on, long off (Programming mode active)		2s		2s		etc.	
LED remains alight (Plug+Play programming is active)							

### Display LED 2 "Fault"

LED flashes long on, short off (Own address incorrect)			0,3s			etc.			
LED flashes long on, short off short on, short off, long on (More than 31 users in the line)			0,3s				etc.		
LED remains alight (Address error at other BNG/BVNG 650-...)									
LED flashes evenly In multiple line systems, more than one ZBVG 650-... connected							etc.		
LED flashes unevenly Unsuitable device connected in Plug+Play mode	0,3s		0,2s			0,3s		0,2s	etc.
LED flashes evenly No BTLM/BTLE connected in Plug+Play mode							etc.		

## 9 Servicing

### Measured values

#### Measured values at the In-Home bus: Video, to be measured with using a digital multimeter

Idle status	min.	max.
Voltage TaM/TbM (TaK/TbK) at bus line rectifier BVNG 650-...	27 V DC	31 V DC
Voltage at most distant user	19 V DC	
Current consumption bus indoor device with colour display	5 mA	
Current consumption bus door loudspeaker	10 mA	
Voltage at +M/-M at the bus indoor device with colour display	20–30 V DC	

#### Call status

Voltage TaM/TbM (TaK/TbK) at bus line rectifier BVNG 650-...	29 V DC	33 V DC
Voltage at most distant user	19 V DC	
Current consumption bus indoor device with colour display (volume dependent)	5 mA	70 mA
Voltage at Vc/GND at the BTLM 650-.../BTLE 050-...	appr. 4 V DC	

#### Speech mode

Voltage TaM/TbM (TaK/TbK) at bus line rectifier BVNG 650-...	27 V DC	31 V DC
Voltage at most distant user	19 V DC	
Current consumption bus indoor device with colour display	max. 400 mA	
Current consumption bus door loudspeaker	80 mA	
Voltage at Vc/GND at the BTLM 650-.../BTLE 050-...	appr. 4 V DC	

#### Multiple line system

Voltage SaV/SbV at bus line rectifier BVNG 650-...	15 V DC	17 V DC
Voltage Sa/Sb at bus line rectifier BVNG 650-...	15 V DC	17 V DC

#### PRI 602-... USB

Voltage b/c	11 V DC	15 V DC
Voltage Sa/Sb	15 V DC	17 V DC
Voltage Da/Db	0.3 V DC	

## 10 Glossary, Index

Terminating resistor	7	AIB 150-...	29	TÖ 615-...	126
Address	11, 37	ANG 600-...	24	VIB 150-...	31
As-delivered status	135	BAA 650-...	14, 22	ZARF 850-...	35
Exchange	135	BCMC 650-...	20	ZAR 850-...	35
Outside light	134	BCM 653-...	20	ZBVG 650-...	11, 34, 122
Operating mode switch	37, 136	BCM 658-...	21	ZBVNG 650-...	9, 34
Classic	19, 52	BEM 650-...	25, 124	ZDS 601-...	133
Compact	19, 48	BEM 651-	25	ZPSF 850-...	35
Single line system	6	BFC 850-...	30	ZPS 850-...	35
Storey call	84, 132	BIM 650-...	26	ZTCV 850-...	33
Troubleshooting	137	BLC 250-...	28	ZTC 800-...	33
Handsfree	29	BNS 750-...	34, 132	ZTS 800-...	33
Radio chime	133	BPS 650-...	28, 122	ZTVP 850-...	33
Commissioning	88	BRMA 050-...	18, 50		
Internal call	99	BSE 650-...	25, 108, 124		
LED display	87, 137	BSE 651-...	25		
Conductor length	6	BSHT 650-...	27		
Light button	84	BSM 650-...	25, 104, 124		
Multiple line system	10	BTCV 850-...	30		
Measured values	138	BTC 850-...	29		
Secondary signal unit	34, 132	BTLE 051-...	18, 50		
Storey call parallel switching	132	BTLM 650-...	18, 37		
Plug+Play	118	BTM 650-...	18, 37		
Programming	80	BTSV 850-...	30		
RC element	7, 36	BTS 850-...	29		
Reset	118, 135	BVD 650-...	26		
Call silencing	84	BVM 650-...	23, 50, 62		
Call tone configuration	84	BVNG 650-...	24		
Servicing	136	BVPC 850-...	31, 40		
Status display (via LED)	84	BVVS 650-...	14, 22		
Steel	19, 54	BVVU 650-...	14, 22		
Control functions	80, 123	CE 600-...	21, 50, 62		
Teach-in	85	CE 950-...	21		
Users	4	CL V xx B-...	19, 52		
Door dialling	85	CV 850-x-...	19, 48		
Door loudspeaker	18	CVU 850-x-...	19		
Doormatic	85	DCA 650-...	28, 66		
Door call	85	DRM 612-...	18, 60		
Door call forwarding	85	DSC 602-...	133		
Door call acceptance	85	NG 602-...	24, 128		
Door release	126	NG 706-30/33-...	24, 40, 129		
Time for light contact	85	PRI 602-...	28, 122		
		PRI 602-... USB	28, 122		
		PSM 1 12 24	24, 128		
		SG 150-...	27, 42		
		SG 650-...	27, 42		
		SI 4 A ..	32, 76		
		SI AI ...	38, 74		
		SI VI ...	38, 72		
		STL	19, 54		
		TR 603-...	24		

Technical additions or printing errors do not constitute grounds for compensation claims.

To supplement this system manual, you will find the latest edition in the download area of our website on [www.siedle.com](http://www.siedle.com)

### Customer service in the Furtwangen factory

+49 7723 63-434

# SSS SIEDLE

S. Siedle & Söhne  
Telefon- und Telegrafentechnik OHG

Postfach 1155  
78113 Furtwangen  
Bregstraße 1  
78120 Furtwangen

Telefon +49 7723 63-0  
Telefax +49 7723 63-300  
[www.siedle.de](http://www.siedle.de)  
[info@siedle.de](mailto:info@siedle.de)

© 2015/07.21  
Printed in Germany  
Best. Nr. 210011031-00 EN